

BT-500

Infant Incubator Operation Manual



Keep this manual for future reference

P/N : 500-ENG-OPM-EUR-R20

Information and descriptions contained in this manual are the property of Bistos Co., Ltd. and may not be copied, reproduced, disseminated, or distributed without express written permission from Bistos Co., Ltd

Information furnished by Bistos Co., Ltd is believed to be accurate and reliable. However, no responsibility is assumed by Bistos for its use, or any infringements of patents or other rights of third parties that may result from its use. No license is granted by implication or otherwise under any patent or patent rights of Bistos.

*Revision 20
March, 2025*

Copyright © Bistos Co., Ltd. 2024. All rights reserved.

Table of Contents

1 Safety

- 1.1 Instructions for the safe operation and use of the device
- 1.2 Warnings
- 1.3 Shock hazards
- 1.4 General precaution on environment
- 1.5 Symbols

2 Introduction

- 2.1 General
- 2.2 Brief device description
- 2.3 Intended use
- 2.4 Operating principles
- 2.5 Essential performance
- 2.6 Accessories and options
- 2.7 Appearance of BT-500
 - 2.7.1 Front view
 - 2.7.2 Front view detail
 - 2.7.3 Rear view
 - 2.7.4 Side view
- 2.8 Description of each part
 - 2.8.1 Control shell
 - 2.8.2 Hood
 - 2.8.3 Mattress tray
 - 2.8.4 Stand

3 Install and connection

- 3.1 IV pole assembly
 - 3.1.1 IV external monitor
 - 3.1.2 IV plate
 - 3.1.3 IV ringer pole
- 3.2 Air filter assembly
- 3.3 Connection of power and cable
 - 3.3.1 Power connection
 - 3.3.2 Cable connection
 - 3.3.3 Sensor module connection
- 3.4 Placement Infant
- 3.5 Movement and lock

4 Operation

- 4.1 System start-up
- 4.2 LED
- 4.3 Key and knob operation
 - 4.3.1 Key
 - 4.3.2 Knob
- 4.4 Displays

- 4.5 Temperature measurement and control
- 4.6 Humidity Measurement and control
- 4.7 O₂ measurement and control
- 4.8 Weighing scale measurement
- 4.9 SpO₂ and PR(pulse rate) measurement
- 4.10 Menu functions
- 4.11 Pulse oximeter
- 4.12 External monitor
- 4.13 Shut down
- 4.14 Calibration of O₂ module

5 Alarms

- 5.1 System characteristics
- 5.2 Alarm information
- 5.3 Alarm self-test

6 Cleaning & Maintenance

- 6.1 General cleaning method and precautions
- 6.2 Hood
- 6.3 Shell, sensor module, scale module, basket
- 6.4 Water tank
- 6.5 Skin temperature sensors and SpO₂ sensors
- 6.6 Drain of residual water
- 6.7 Regular inspection
- 6.8 Battery replacement and disposal
- 6.9 Disposal of the BT-500

7 Specification

8 Troubleshooting

- 8.1 General checking
- 8.2 Error message checking

9 Declaration on EMC

- 9.1 Electromagnetic emissions
- 9.2 Recommended separation distances between portable and mobile RF communications equipment and the BT-500
- 9.3 Electromagnetic immunity

Warranty

1 Safety

1.1 Instructions for the Safe Operation and Use of the device

- Examine the incubator and any accessories periodically to ensure that the cables, line cords and instruments do not have visible evidence of damage that may affect patient safety or performance. The recommended inspection interval is once per week or less. Do not use the incubator if there is any visible sign of damage.
- Only the AC line cord supplied with the BT-500 is approved for use with the Unit.
- Do not attempt to service the BT-500 incubator. Only qualified service personnel by Bistos Co., Ltd. should attempt any needed internal servicing.
- The BT-500 is not specified or intended for operation during the use of defibrillators or during defibrillator discharge.
- The BT-500 is not specified or intended for operation in the presence of electrosurgical equipment.
- The BT-500 is not specified or intended for operation in conjunction with any other type of equipment except the specific devices that have been identified for use in this Operator's Manual.
- Perform periodic safety testing to insure proper patient safety. This should include leakage current measurement and insulation testing. The recommended testing interval is once per year.
- Do not operate the BT-500 incubator if it fails to pass the power on self-test procedure.



Be informed that it may cause serious injury or death to the patient, property damage, material losses against the "WARNING" sign.



Be informed that it may cause no harm in life but lead to injury against the "CAUTION" sign.



Be informed that it may cause serious electrical shock to the patient or operator, property damage, material losses against the "SHOCK HAZARD" sign.

1.2 Warnings

Side effect

- Some patients may require more frequent inspection, such as patients with perfusion disorders or sensitive skin, because persistent and prolonged monitoring may increase unpredictable skin changes, such as allergies, redness, blistering, or pressure necrosis.

WARNING



- Improper use of oxygen concentration may be associated with serious complications including hyperoxia, central nervous system or pulmonary damage, retinopathy of prematurity.
- Because an infant is valuable to exposure to pathogenic organisms from the hospital environment, proper control of the incubator and monitoring the infant is important.

Otherwise it may be associated with sepsis.

- The method, the concentration, and duration of oxygen administration, temperature level, humidity level and their period of control should be prescribed by the attending physician.
 - Thoroughly read and understand the manual prior to use of the incubator. Failure to do so could result in personal injury or equipment damage.)
 - Incubator misuse may result in harm to an infant. Only properly trained personnel should use the incubator as directed by an appropriately qualified attending physician aware of currently known risks and benefits.
 - Use of accessories other than those listed and approved for use in this product as original or replacement items may result in increased emissions or decreased immunity.
 - The total electrical current leakage of all items powered through the incubator, including devices on the outlet strip, must be less than 300uA for 120V AC/ 100V AC systems and less than 500uA for 230V AC systems. Otherwise, personal injury or equipment damage could occur.
 - The use of accessory equipment not complying with the equivalent safety requirements of this equipment may lead to a reduced level of safety of the resulting system. Consider the use of the accessory in the patient's vicinity and evidence that the safety certifications of the accessory have been performed in accordance with the appropriate International Electrotechnical commission (IEC) 60601-1 harmonized national standard. Personal injury or equipment damage could occur.
 - Devices connecting to the serial data port must be compliant with EN 60601-1-2, the EMC requirement for Medical Devices. Failure to do so could result in personal injury or equipment damage.
 - Medical electrical equipment needs special precautions regarding EMC and needs to be installed and put into service according to the EMC information provided in this manual. In addition, portable and mobile RF communications equipment can effect medical electrical equipment.
 - The equipment shall not be used adjacent to or stack with other devices unless verification of normal operation in the configuration in which it is to be used can be achieved.
 - Use only Bistos recommended fuel cells for proper operation. Failure to do so could result in personal injury or equipment damage.
 - Higher incubator relative humidity at any given temperature decreases an infant's evaporative heat loss, and may cause an increase in the infant temperature. Routinely monitor the infant's rectal and/or axillary temperature according to the attending physician's orders or Nursery Standing Orders. Failure to do so could result in personal injury.
 - Higher relative humidity will, at any given time, decrease an infant's evaporative water loss, and may cause an increase in infant temperature. This effect is greatest in very low birth-weight, premature infants. The attending physician should prescribe Temperature Control mode, temperature setting, and humidity output level setting. Routinely monitor the infant's rectal and/or axillary temperature according to the attending physician's
-

orders or Nursery Standing Orders. Failure to do so could result in personal injury.

- Fill the reservoir to the Maximum Filling Limit line. Do not overfill. Water spillage may result, and personal injury could occur.
 - Use distilled water only (<10 ppm total dissolved solids). The use of sterile water or saline solution is not acceptable. Equipment damage could occur.
 - For proper operation of the incubator, use only skin temperature probes from Bistos Co. Ltd. Using other probes could result in personal injury or equipment damage.
 - Never place the skin temperature probe under the infant or use it rectally. Personal injury could occur.
 - BT-500 cannot differentiate between an increase in core temperature with a cold skin (fever) and a low core and skin temperature (hypothermia). The temperature of the infant is monitored separately.
 - When in skin mode, the skin temperature probe must be in direct contact with the skin to provide accurate monitoring of the infant's skin temperature. When in skin mode, failure to maintain direct skin contact can result in overheating. Routinely check the infant's condition for correct sensor attachment, and feel the infant's skin for signs of overheating.
 - When an x-ray is taken through the hood, the hood could show up on the x-ray as a radiolucent shadow and could result in incorrect diagnosis.
 - Do not use in the presence of flammable anesthetics. Personal injury or equipment damage could occur.
 - Keep matches, and all other sources of ignition, out of the room in which the incubator is located. Textiles, oils, and other combustibles are easily ignited and burn with great intensity in air enriched with oxygen. Personal injury or equipment damage could occur.
 - Small quantities of flammable agents, such as ethyl and alcohol, left in the incubator may cause a fire in connection with oxygen. Personal injury or equipment damage could occur.
 - A fire and explosion hazard exists when performing cleaning or maintenance procedures in an oxygen-enriched environment. Make sure that oxygen supply is turned Off and the oxygen hose to the incubator is disconnected when performing cleaning and maintenance procedures. Turn off or disconnect oxygen supplies during periods of non-use. Failure to do so could result in personal injury or equipment damage.
 - If it is necessary to administer oxygen in an emergency, notify the attending physician immediately. Failure to do so could result in personal injury or equipment damage.
 - Administration of oxygen may increase the noise level for the infant within the infant incubator.
 - An oxygen analyzer shall be used separately when oxygen is delivered to the infant.
 - Measure the oxygen concentrations to verify delivery of the prescribed oxygen concentration. Failure to do so could result in personal injury or equipment damage.
 - If the patient's arterial oxygen levels cannot be maintained when the oxygen control setting is set to maximum, the attending physician should prescribe alternate means of
-

oxygenation. Failure to do so could result in personal injury or equipment damage.

- The oxygen concentration inspired by an infant does not accurately determine the partial pressure of oxygen(pO_2) in the blood. When deemed advisable by the attending physician, measure blood pO_2 by accepted clinical techniques. Failure to do so could result in personal injury or equipment damage.
 - Disconnect the incubator from the hospital oxygen source when oxygen is not in use. Failure to do so could result in personal injury or equipment damage.
 - As oxygen use increases the danger of fire, do not place auxiliary equipment that produces sparks in an incubator. Personal injury or equipment damage could occur.
 - Use of anesthetic agents can interfere with oxygen analyzer accuracy.
 - Inspect gas/oxygen service components at regular service intervals for signs of corrosion or damage. Failure to do so could result in personal injury or equipment damage.
 - A dirty air intake micro filter could affect performance or cause carbon dioxide(CO_2) build-up. Ensure that the filter is checked on a routine basis commensurate with local conditions. Particularly, if the unit is used in an unusually dusty environment, more frequent replacements may be necessary. Failure to do so could result in infant injury or equipment damage.
 - After each change of oxygen flow, allow at least 30 min to achieve new concentrations. Failure to do so could result in personal injury or equipment damage.
 - Compressed gas cylinders, such as oxygen cylinders, can become hazardous projectiles if the gas is released rapidly due to damage or other causes. Securely fasten the cylinder. Failure to do so could result in personal injury or equipment damage.
 - Oxygen levels within the incubator hood environment may be affected when the access doors or access panels are opened. Make sure all hood access door gaskets and tubing ports are properly installed. Any open gaps in the incubator hood may reduce the incubator's internal oxygen. Personal injury could occur.
 - Make sure all hood access door gaskets and tubing ports are properly installed. Any open gaps in the incubator hood will reduce the incubator's internal relative humidity. Personal injury or equipment damage could occur.
 - The use of infant seats, or other accessories within the incubator that can alter the airflow pattern, may affect temperature uniformity, temperature variability, the correlation of the incubator temperature reading to center mattress temperature and infant skin temperature. Personal injury could occur.
 - Phototherapy units located too close to the incubator may affect hood wall temperature, incubator hood temperature, and infant skin temperature. Personal injury or equipment damage could occur.
 - Phototherapy lamps placed over the top of the incubator hood may interfere with upward travel of the vertical height adjustable stand. To prevent this interference, always remove the phototherapy lamp prior to positioning the stand.
 - If airflow passages are not kept clear of obstructions, such as blankets and stuffed animals, during clinical usage, patient safety and incubator performance may be
-

compromised.

- To avoid overheating the infant due to direct radiation, do not position the incubator in direct sunlight or under other sources of radiant heat.
 - Do not place surgical covers or blankets over the infant and warm air curtain of side vents simultaneously. This may cause heat-induced injury and burns.
 - To prevent accidental disconnection, secure all patient leads, infusion lines, and ventilator tubing to the mattress with sufficient excess length to allow for the full range of mattress height adjustment.
 - Only connect equipment to the serial port that complies with the relevant IEC standard; and use data cables with plastic body connectors.
 - Do not raise the hood at any time while the infant is in the incubator. Gain access to the infant by the access panels and access doors. Failure to do so could result in personal injury or equipment damage.
 - When the front access panel (or optional rear) is open, the temperature display may not accurately reflect the incubator temperature. Do not leave the front access panel (or optional rear) open longer than essential. Personal injury could occur.
 - Positively secure all access panel latches to avoid accidental opening, Failure to do so could result in personal injury or equipment damage.
 - For infant safety, do not leave the infant unattended when the access panels are open. Personal injury could occur.
 - When opening the access panels, make sure to hold it with your hands all the way and open it. Failure to do so could result in personal injury or equipment damage.
 - Always use two people when moving the incubator and patient together. When moving the incubator within the same floor space, check that the patient is secured safely in the unit and either remove or secure all loose system components to prevent possible patient injury or equipment damage. If the move involves varying floor heights or a complete floor level change (i.e. thresholds, ramps, elevators), remove all items either not being used or not necessary for the move, lower the VHA, IV poles and shelves to their lowest position, place all drawers in their locked state, and remove all accessories from the front and rear rail position.
 - Never place objects taller than the top of the wheel casters beneath the incubator stand. Placement of objects there could interfere with the stability of the vertical height adjustable stand. Personal injury or equipment damage could occur.
 - To avoid possible tip-over or damage to adjacent carts, IV stands, shelves, etc., keep at least a 12" (30 cm) perimeter area clear around the vertical height adjustable stand.
 - For optimum incubator stability, always lock all stand wheels, Do not leave the unit unattended when parking on an incline. Failure to do so could result in personal injury or equipment damage.
 - When raising or lowering the incubator, the operator should ensure that both equipment and appendages are clear of the unit's travel path. Patient and incubator connections must also be checked before adjusting the incubator height. Never place any objects on top of the drawer assembly and always check before lowering the VH that there is
-

sufficient clearance between the incubator and stand assembly. Do not raise or lower the unit while installing or removing medical gas tanks from the tank holder assembly. Failure to do so could result in personal injury or equipment damage.

- The UART port is for debugging purposes only. It does not allow connections with other devices.
 - Prior to placing the infant in the incubator, pre-warm the incubator to the temperature prescribed by the attending physician, or according to nursing protocol.
 - Only one monitor shelf should be used per incubator. When using the monitor shelf, always place the monitor in the center of the shelf, ensure that the monitor fits within the border of the shelf, and avoid stacking monitors on the shelf. Personal injury or equipment damage could occur.
 - Attach the incubator to the stand or the vertical height adjustable stand using the bolts provided. Failure to do so could result in the incubator separating from the stand if sufficiently tilted, particularly with the hood open. Personal injury or equipment damage could occur.
 - This product has been validated with the accessories and options listed in this manual and found to comply with all relevant safety and performance requirements applicable to the device. It is therefore the responsibility of that person or organization who makes an unauthorized modification, or incorporates an unapproved attachment to the device, to ensure that the system still complies with those requirements.
 - A pulse oximeter should NOT be used as an apnea monitor
 - Pulse rate measurement is based on the optical detection of a peripheral flow pulse and therefore may not detect certain arrhythmias. The pulse oximeter should not be used as a replacement or substitute for ECG based arrhythmia analysis.
 - A pulse oximeter is an early warning device. Use lab co-oximeter to completely understand the patient's condition.
 - Do not use the MS board pulse oximeter in the presence of flammable anesthetics or other flammable substance in combination with air, oxygen enriched environments, or nitrous oxide.
 - Do not remove the monitor cover except to replace the battery. An operator may only perform maintenance procedures specifically described in this manual. Refer servicing to Masimo in repair of this equipment.
 - Leakage current must not exceed 100 microamperes; measure when an external device is connected to the serial port.
 - Do not use Masimo oximetry sensors during MRI scanning as it could potentially cause burns.
 - Inaccurate measurements may be caused by incorrect application or use.
 - Inaccurate measurements may be caused by significant levels of dysfunctional hemoglobin (HbCO or MetHb).
 - Inaccurate measurements may be caused by intravascular dyes such as indocyanine
-

green or methylene blue.

- Inaccurate measurements or loss of pulse signal may be caused by excessive illumination.
 - Inaccurate measurements may be caused by excessive patient movement.
 - Inaccurate measurements may be caused by venous pulsation.
 - Inaccurate measurements or loss of pulse signal may be caused by placement of a sensor on an extremity with a blood pressure cuff, arterial catheter or intravascular line.
 - The MS board pulse oximeter can be used during defibrillation, but the readings may be inaccurate for a short time.
 - Loss of pulse signal can occur when the sensor is too tight.
 - Loss of pulse signal can occur when the patient has hypotension, severe vasoconstriction, severe anemia, or hypothermia.
 - Loss of pulse signal can occur when there is arterial occlusion proximal to the sensor.
 - Loss of pulse signal can occur when the patient is in cardiac arrest or is in shock.
 - Use only Masimo sensors for SpO2 measurements.
 - Tissue damage can occur due to incorrect placement of sensor.
 - When the measured value is not completed, then the “---” is displayed.
 - During long time continuous monitoring of a patient, check the position of SpO2 sensor once every 2 hours, and move properly when the skin changes or every four hours.
-







1.3 Shock hazards

**SHOCK
HAZARD**

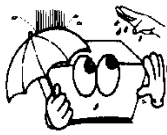
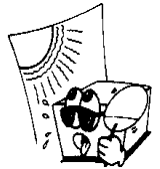
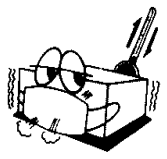
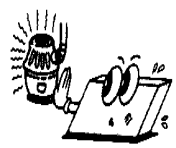

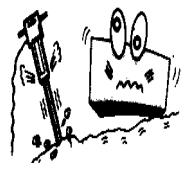
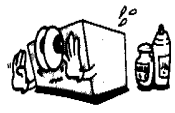













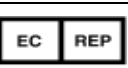

- Unplug the unit from its power source prior to cleaning or maintenance. For units equipped with an uninterruptible power supply(UPS) system, also remove the battery pack prior to cleaning or maintenance. Failure to do so could result in personal injury or equipment damage.
 - Some chemical cleaning agents may be conductive and leave a residue that may permit a build-up of conductive dust or dirt. Do not allow cleaning agents to contact electrical components, and do not spray cleaning solutions onto any of these surfaces. Personal injury or equipment damage could occur.
 - To ensure grounding reliability, plug the AC power cord only into a properly grounded 3-wire hospital-grade or hospital-use outlet. Do not use extension cords. If any doubt exists as to the grounding connection, do not operate the equipment. Personal injury or equipment damage could occur.
 - Do not expose the unit to excessive moisture that would allow for liquid pooling. Personal injury or equipment damage could occur.
 - Due to the risk of electrical shock hazard, only qualified personnel with appropriate service documentation should service the unit.
 - Batteries can present a risk of electric shock. The following precautions should be taken when working on batteries: remove watches, rings or other metal objects; use tools with insulated handles.
 - The total power of all equipment connected to the convenience outlet strip on the pedestal / stand must be within the electrical requirements shown on the rear of the pedestal / stand. Otherwise, personal injury or equipment damage could occur.
 - Make sure the Building power source is compatible with the electrical specifications shown on the column of the pedestal / stand and on the incubator. Failure to do so could result in personal injury or equipment damage.
 - To prevent equipment damage or accidental power disconnections, do **not** plug an incubator power cord directly to an AC wall socket when the incubator is mounted on a pedestal /stand. Always provide power to the incubator by using the power cord coming directly from the pedestal /stand.
-

1.4 General precaution on environment

Do not keep or operate the equipment under the environment listed below.

	<p>Avoid placing in an area exposed to moisture. Do not touch the equipment with wet hand.</p>		<p>Avoid exposure to direct sunlight</p>
	<p>Avoid placing in an area where there is a high variation of temperature. Operating temperature ranges from 20°C to 30°C. Operating humidity ranges from 0% to 95%.</p>		<p>Avoid in the vicinity of Electric heater</p>
	<p>Avoid placing in an area where there is an excessive humidity rise or ventilation problem.</p>		<p>Avoid placing in an area where there is an excessive shock or vibration.</p>
	<p>Avoid placing in an area where chemicals are stored or where there is in danger of gas leakage.</p>		<p>Avoid dust and especially metal material into the equipment.</p>
	<p>Do not disjoint or disassemble the equipment. BISTOS Co., Ltd. does not take responsibility of it.</p>		<p>Power off when the equipment is not fully installed. Otherwise, the equipment could be damaged.</p>

1.5 Symbols

Symbol	Description
	Used to identify safety information. Be well-known this information thoroughly before using BT-500. During the operation, do not disconnect any cable.
	Indicate the warning for hot surface.
	Type BF Applied part
	Refer to operation manual. Read manual before placing the device.
	Skin temperature sensor #1, to be connected to infant's abdomen for skin mode
	Skin temperature sensor #2, to be connected to other than infant abdomen
IPX0	IPX0 Non-protected against ingress of water with harmful effects. (Device)
IPX1	IPX1 Protected against the vertically dripping water (Skin temperature sensor_2EA)
IPX2	IPX2 Protected against the dripping water (SpO ₂ sensor)
IPX6	IPX6 Protected against the powerful jetting (Foot switch_2EA)
	Indicates the weight limit
	This symbol indicates the manufacturer.
	This symbol indicates the serial number of the device.
	This symbol indicates the authorized representative in the European Community of manufacturer.
	This symbol indicates to keep the device dry.
	This symbol indicates to keep the correct upright position on the transport package.
	This symbol indicates the device is fragile.
	This symbol indicates the temperature limitation for operation, transport and storage.
	This symbol indicates the humidity limitation for operation, transport and storage.
	This symbol indicates the packing material is recyclable.
	External Signal IN/OUT Port
	This symbol indicates the compliance with the essential requirements and provisions of the Medical Device Directive 93/42/EEC as amended by 2007/47/EEC.
	This symbol indicates to not dispose the device together with unsorted municipal waste(for EU only). The solid bar symbol indicates that mains adapter is put on the market after 13 August 2005.

2 Introduction

2.1 General

This chapter provides a general description of the BT-500 infant incubator including.

- Brief Device Description
- Product Features
- Model Configurations

2.2 Brief Device Description

A mains electricity (AC-powered) unit designed to provide an enclosed controlled environment to maintain appropriate temperature and humidity levels mainly for premature infants and other newborns who cannot effectively regulate their body temperature. It typically consists of a clear removable plastic hood with a mattress. It typically includes a means to warm the infant such as providing heated air; temperature controls that work automatically either by measuring the air temperature or through a temperature sensor attached to the infant skin; and humidity controls. The device is intended to use in a hospital.

2.3 Intended Use

BT-500 is an infant incubator for non-invasively measuring and showing graphically humidity, air temperature, skin temperature, O₂ Module, weight and SpO₂. This data is intended to aid the maintaining life of a premature baby or a precocious baby under 2kgs. This device is for use only by trained medical personnel located in hospital. Also this device can be used in the all departments of the hospital which offers a neonatal care service such as NICU (Neonatal Intensive Care Unit), special nursery unit and pediatrics.

2.4 Operating Principles

- Air and skin temperature measurement and Control: Internal cartridge heater raises the temperature. The infant environmental temperature value is determined by air or skin temperature that is measured by the sensor module. Through the main fan, the air is circulated within the hood and controls the temperature.
- Humidity measurement and control: The steam of humidity module vaporizes the water particles. It controls the humidity within the hood. The water is sterilized by boiling it to 100°C.
- O₂ Module (Optional): The oxygen concentration in the hood is controlled when the oxygen option was attached.
- SpO₂ measurement (Optional): The SpO₂ of infant can be measured when the option was installed. The probe sensor is applied to the end of an infant's fingertip/toe or foot. By measuring the intensity of reflected light which is dependent on the concentration of dissolved oxygen in the blood, the oxygen saturation can be determined.
- Pulse rate measurement (PR): During the SpO₂ measurement, the light reflected by blood is pulsates by the heartbeat. By measuring this pulsation, the device can determine the pulse rate of the subject.

2.5 Essential performance

1) Accuracy of control

The temperature as measured by the skin temperature sensor should not differ from the control temperature by more than 0.5 °C in skin mode.

The temperature as measured by the air temperature sensor should not differ from the control temperature by more than 0.5 °C in air mode.

The humidity as measured by the humidity sensor should not differ from the control humidity level by more than 5 %.

2) Accuracy of measurement

The skin temperature measurement accuracy is ± 0.3 °C.

If the module is equipped, the SpO2 measurement accuracy is ± 3 % in range of 70 – 100 %.

If the module is equipped, the Pulse rate measurement accuracy is ± 3 bpm in range of 30 to 240 bpm.

3) Display

The incubator displays the measurement value of skin temperature, and if the module is equipped, the SpO2 and pulse rate measurement value.

4) Generation of visual and audible alarm

If the temperature measured is lower than the set temperature over 2.5 °C, alarm for Low air temperature occurs.

If the measured temperature is higher than the set temperature over 1.5 °C, alarm for High air temperature occurs.

If the temperature measured is lower than the set temperature over 1.0 °C, alarm for Low skin temperature occurs.

If the measured temperature is higher than the set temperature over 1.0 °C, alarm for High air temperature occurs.









If the device cannot get a stable power supply, technical alarm occurs.





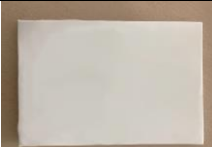

If the module is equipped, alarm for low SpO2, high and low pulse rate occurs based on the set limit.

WARNING Do not use the skin temperature control on babies who are in shock or who have high temperatures

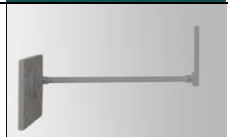

2.6 Accessories and options

Picture	Name	Description	Qty
	Control shell (Standard)	Hold up the hood and be composed with instruments and parts that control the temperature and humidity	1ea
	Hood (Standard)	Made of double framed clear acrylic panel to watch inside, and to minimize heat loss	1ea
	Fixed Stand (Standard)	Movable incubator cradle with wheels	1ea
	Basket (Optional)	Storage of medical equipment and items which infant needs	1ea
	Basket Partition (Optional)	Partition of Basket	1ea
	Sensor module (Standard)	Measures temperature and humidity inside the hood and infant's body temperature	1ea
	Mattress tray (Standard)	Baby desk with X-ray tray	1ea
	mattress (Standard)	Accommodate infant stably with bouncy mattress	1ea
	Skin temperature sensor (Standard)	Measures infant's skin temperature Model: W0001C	2ea
	IV-pole (Optional)	IV hanger.	1ea
	AC power code (Standard)	AC Power cord(AC Power cord for operating the equipment)	1ea
	External LCD Monitor (Optional)	Displays measured values from the control and video of infant inside the hood.	1ea

	CCD Camera (Optional)	Takes video of infant inside the hood	1ea
	Masimo SpO ₂ sensor probe (Optional)	Measures infant's SpO ₂ Model: Masimo M-LNCS series	1ea
	Masimo Extension for SpO ₂ sensor (Optional)	Extend sensor cable Model: Masimo SET M-LNC Patient Cable M-LNC-10	1ea
	IV plate (Optional)	Plate to place items which infant needs	1ea
	Shelf (Optional)	Plate to place items which infant needs	1ea
	Lift Stand (Optional)	Movable incubator cradle with wheels (VHA-Variable Height Adjustable)	1ea
	Weighing Scale (Optional)	Measures Infant's weight	1ea

Notes;

* The built-in air filter requires periodic replacement to maintain clean air. Periodic replacement of the pads according to the maintenance schedule is recommended.

**Oxygen control module is also available as an optional component.

2.7 Appearance of BT-500

2.7.1 Front View



- ① Control Shell
- ② Hood
- ③ Sensor module
- ④ Moving Stand
- ⑤ Basket
- ⑥ IV pole
- ⑦ IV plate
- ⑧ External monitor

Figure 2-1. Front view

2.7.2 Front View Detail

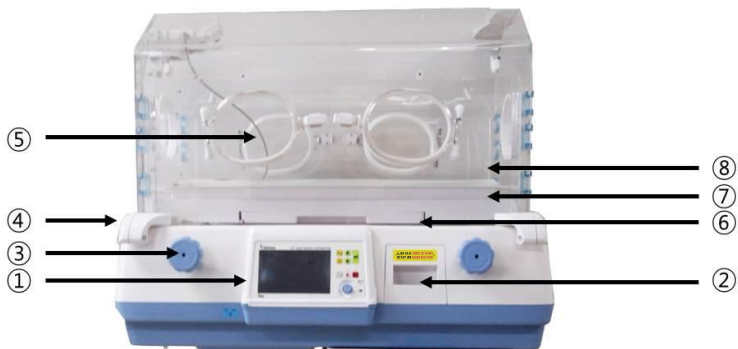

- ① Console box
- ② Water tank draw
- ③ Tilting mechanism handle
- ④ Hood handle
- ⑤ Front access door
- ⑥ Baby desk with X-RAY tray
- ⑦ Weighing scale
- ⑧ Compatible mattress

Figure 2-2. Front view details

2.7.3 Rear view



- ① Rear access door
- ② AC power cord & connector

Figure 2-3. Rear view

2.7.4 Side view



Figure 2-4. Left view



Figure 2-5. Right view

2.8 Description of each part

BT-500 is composed with several parts. The control shell is the part which controls the entire device. To measure the infant's environment, the sensor module is needed. The hood is used to protect an infant from the external environment and maintain the internal environment of hood to best condition.

2.8.1 Control shell

The control shell part consists of console box and water tank.

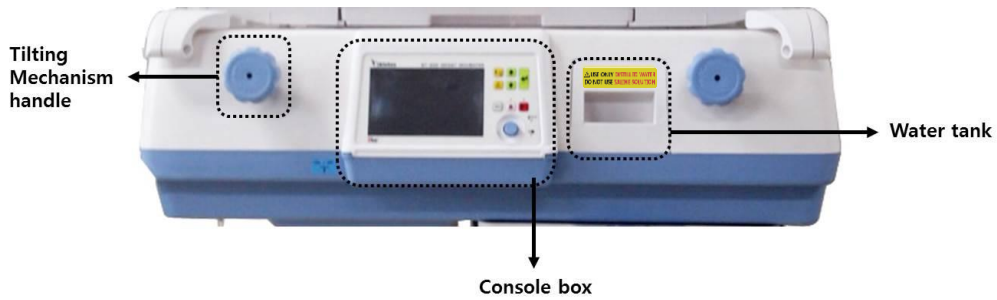



Figure 2-6. Control Shell

The water tank has a 1 Liter capacity. The reservoir permits visual inspection of the water level. It is located in a drawer in the front of the shell. When the drawer is closed and the latching handle is engaged, the reservoir is connected to heater module. For more information about how to clean, see "Chapter 6 cleanliness and maintenance"



WARNING  Use distilled water only (<10 ppm total dissolved solids). The use of sterile water or saline solution is not acceptable. Equipment damage could occur.

2.8.2 Hood

The hood of BT-500 is an acrylic material. There is Access door in the front, rear and both sides of hood.

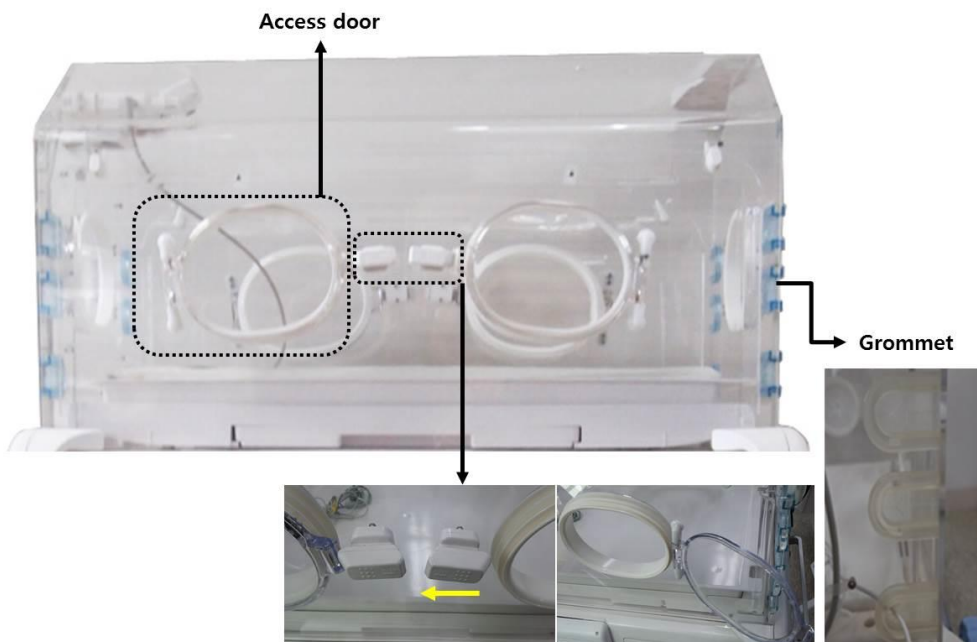

Figure 2-8. Hood front view & Access door / side function

WARNING To prevent accidental disconnection, secure all access panel latches. Failure to do so could result in personal injury of equipment damage.



2.8.3 Mattress tray

- Rotate the pawl latches, and open the front access panel.
- Pivot the front access panel to the full open position (hanging straight down).
- Slide out the mattress tray to the fully extended position (up to 22cm).
- Carefully lean on the mattress tray to ensure it is properly supported and provides a firm infant platform.
- Return the mattress tray.
- Close the front access panel, and rotate both latches until they are fully engaged.

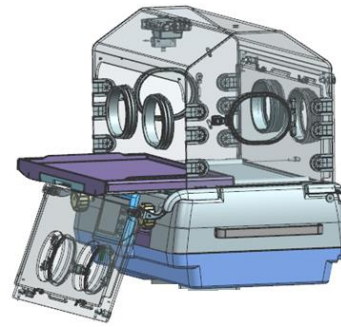

Max. to 220mm
Weight limit : under 20kg

2.8.4 Stand

BT-500 has two types of stand as fixed and lifting. Following figure show the fixed stand. In case of lifting type, you are able to adjust the vertical height using two sets of up/down arrow on footswitch. (VHA - Variable Height Adjustable) This type is optional. The height of the stand can be adjusted if necessary by stepping on an appropriate side of the pedal for height adjustment.



Figure 2-12. Fixed Stand (Standard)



Figure 2-13. Lifting Stand (Optional)

WARNING • When raising or lowering the incubator, the operator should ensure that both equipment and appendages are clear of the unit's travel path. Patient and incubator connections must also be checked before adjusting the incubator height. Never place any objects on top of the drawer assembly and always check before lowering the VHA that there is sufficient clearance between the incubators and stand assembly. Do not raise or lower the unit while installing or removing medical gas tanks from the tank holder assembly. Failure to do so could result in personal injury of equipment damage.



3 Install and Connection

Attention to follow direction for installing BT-500.

- Use this device in 20~30 °C of environmental temperature and 0~90 % of humidity.
- Check the connection of the AC power cord and then use this cord,
- Caution to this device because of easy to break.
- When connecting AC power cord, connect the one electrical outlet and infant incubator.
- Install the main body on horizontal location.
- Do not use the electrical cord connected to generate a noise.
- Install away from dust or inflammable material

3.1 IV pole Assembly

The IV poles can be mounted as below. Check each Part name and number

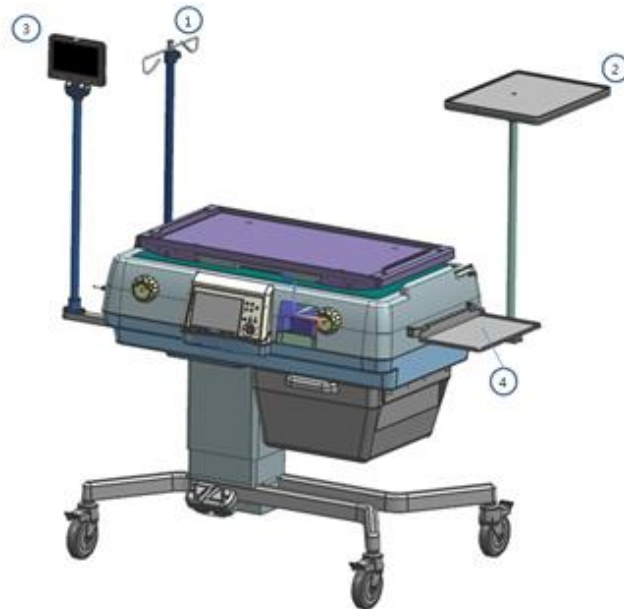

- ① IV ringer pole assembly
- ② IV plate assembly
- ③ IV external monitor assembly
- ④ Shelf

3.1.1 IV External monitor

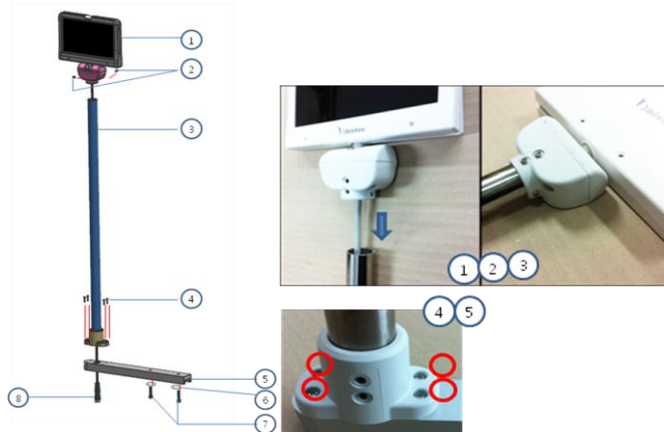

- ① LCD monitor assembly (1ea)
- ② Machine screw M5x5 (3ea),
Hexagon wrench 2.5mm
- ③ IV LCD pipe, 25.4mm (1ea)
- ④ Machine screw M3x12 (4ea), pan head
- ⑤ IV LCD frame (1ea)
- ⑥ Lock washer M6 (2ea)
- ⑦ Screw M6x25 (2ea),
Hexagon wrench 5mm
- ⑧ LCD monitor assembly cable (1ea)

3.1.2 IV plate

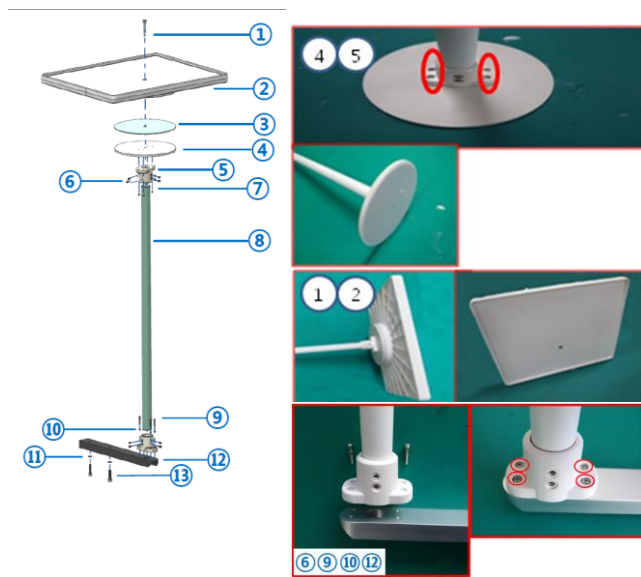

- ① IV plate bolt (1ea), hexagon wrench
- ② IV plate (1ea)
- ③ IV plate bushing, 2T (1ea)
- ④ IV plate support, 5T (1ea)
- ⑤ IV pole guide (2ea)
- ⑥ Socket screw M5x5 (8ea), hexagon wrench 2.5mm
- ⑦ Machine screw M3x12, pan head (4ea)
- ⑧ IV plate pole, 25mm (1ea)
- ⑨ Machine screw M3x18, pan head (4ea)
- ⑩ Spring washer M3 (4ea)
- ⑪ Lock washer M6 (2ea)
- ⑫ IV plate frame (1ea)
- ⑬ Screw M6x25 (2ea), hexagon wrench 5mm

3.1.3 IV ringer pole

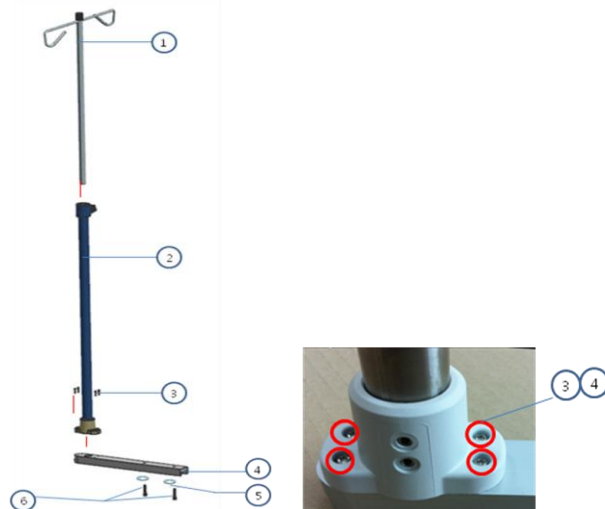

- ① Ringer pole (1ea)
- ② IV ringer pipe, 25.4mm (1ea)
- ③ Machine screw M3x12, pin head (4ea)
- ④ IV LCD frame (1ea)
- ⑤ Lock washer M6 (2ea)
- ⑥ Screw M6x25 (2ea), hexagon wrench 5mm

3.2 Air Filter Assembly

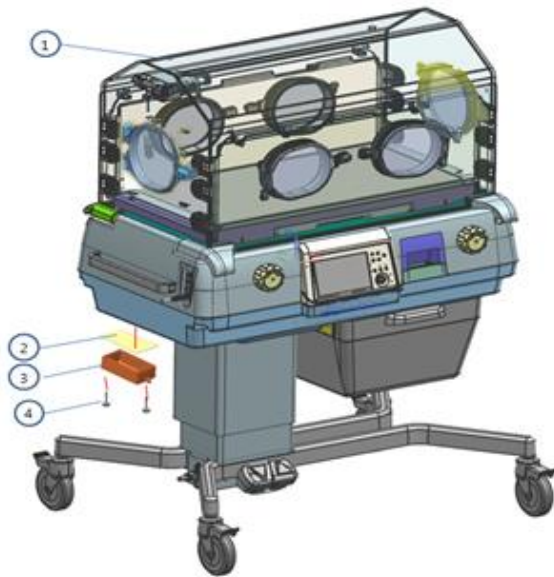

- ① Total assembly
- ② Micro filter (1ea)
- ③ Filter cover (1ea)
- ④ Filter cover bolt (2ea)

WARNING • Air filter exchange period is once in 3 month. Please check frequently and carefully that it is not dirty.



3.3 Connection of Power and Cable

3.3.1 Power Connection

Connect 110V or 220V AC power cord to power, and connect the code to the power input terminal one side of the body below the BT-500 body. At that time, make sure latch the cord by using the locking device for prevent of unexpected separation. Afterward, it is operated by pushing the power switch located at the bottom of the front of the device as shown.

When power is supplied normally, the power indicator LED is lit and Self-test screen appears at the same time.



3.3.2 Cable Connection

Connect all probes and cables to the sensor part in the hood and left and rear part of stand as shown.

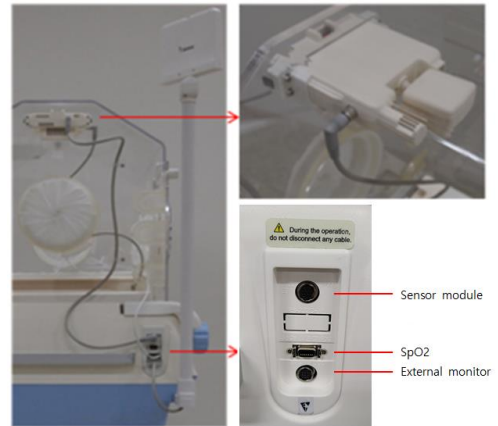

-
- WARNING** • When inserting or removing the connectors, be careful not to put or pull the cable by force or twist it. Be sure to confirm the position, direction and shape and to pull lightly the locking metal part of the end of the cable. Failure to do so could result in personnel injury or equipment damage.
-

3.3.3 Sensor Module Connection

Connect the sensor module as shown. Remove the connector of the sensor module. While pulling the both guide locks, pull the sensor module out of the hood.

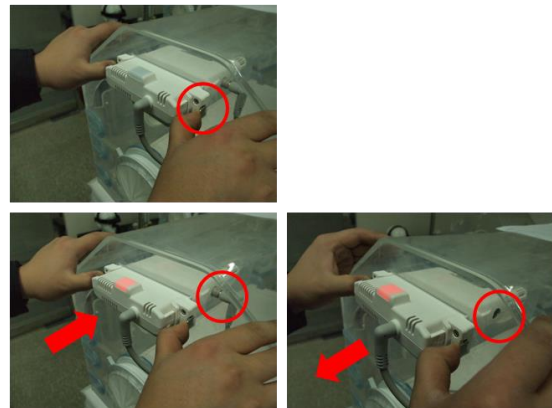

3.4 Placement Infant

To place an infant in the incubator, perform the following:

- 1) Pre-warm the incubator.
- 2) Rotate the pawl latches and open the front access panel of hood.
- 3) Place the infant on the center of the mattress carefully.
- 4) Close the front access panel and ensure the pawl latches are fully engaged.

-
- WARNING** • Prior to placing the infant in the incubator, pre-warm the incubator to the temperature prescribed by the attending physician, or according to nursing protocol.
-

3.5 Movement and lock

To move the position of incubator, perform the following:

- 1) Identify that infant is not in incubator.
- 2) Turn off all accessories plugged into the stand receptacles and remove accessories and items not in use during movement.
- 3) In case of VHA, adjust the stand to its lowest position prior to move the equipment.
- 4) Coil up the power cord and secure it.

WARNING



- Never move the incubator when there is an infant in the incubator.
 - Always push or pull the incubator forward or backward in a straight line along the length of the stand (from the ends). Lateral or angular movement (across the width) can result in inadvertent tip-over if the wheels encounter any obstacle. Personnel injury or equipment damage could occur.
 - Always use two people when moving the incubator. When moving the incubator within the same floor space, And remove or secure all loose system components to prevent possible patient injury or equipment damage. If the move involves varying floor heights or a complete floor level change (i.e. thresholds, ramps, elevators), remove all items either not being used or not necessary for the move, lower the VHA, IV poles and shelves to their lowest position, place all drawers in their locked state, and remove all accessories from the front and rear rail position.
 - Always close and latch drawers when not in use and particularly when the incubator is being moved.
 - For optimum stability, always lower the incubator to its lowest position prior to transport. Make sure that items placed on the monitor shelf are properly secured. Failure to do so could result in personal injury or equipment damage.
-

To place the BT-500 in desired place, you should lock the two casters on the stand. To lock a caster, lower the stopper on the caster to the locking position. To unlock a caster, raise the stopper.



CAUTION



- Install the incubator on a horizontal and stable place. Step on the two stoppers to lock the casters securely. To move the incubator to another place, be sure to unlock the casters.
 - The AC power plug is a means to isolate its circuits electrically from the supply mains on all poles simultaneously. Do not place the device in an area when there is difficult to disconnect from the supply mains.
-

4 Operation

4.1 System Start-up

- 1) Turn on the power switch in the bottom left of the BT-500 front.



- 2) Then check the following logo is displayed in the main LCD.

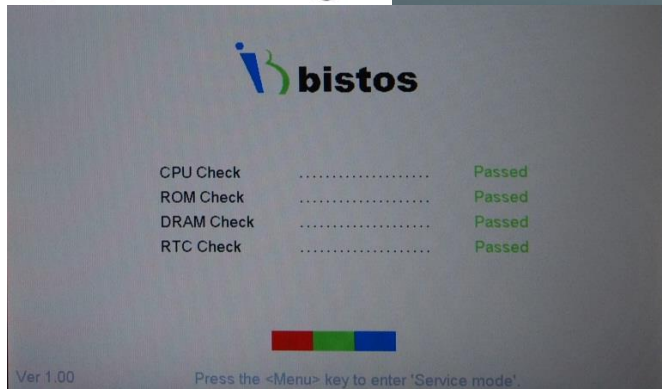

- 3) Make sure the system check screen is being output. Make sure each piece of equipment is functioning properly. The connection may differ depending on the options and modules connected or not.

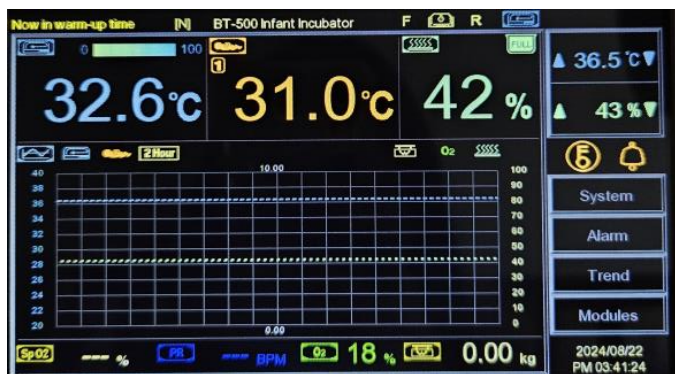

- 4) Ensure that the various items properly output to the main display screen of the product. If the O₂ control option has been added to the main display screen it can be changed to control the O₂ concentration inside the incubator.



Control panel

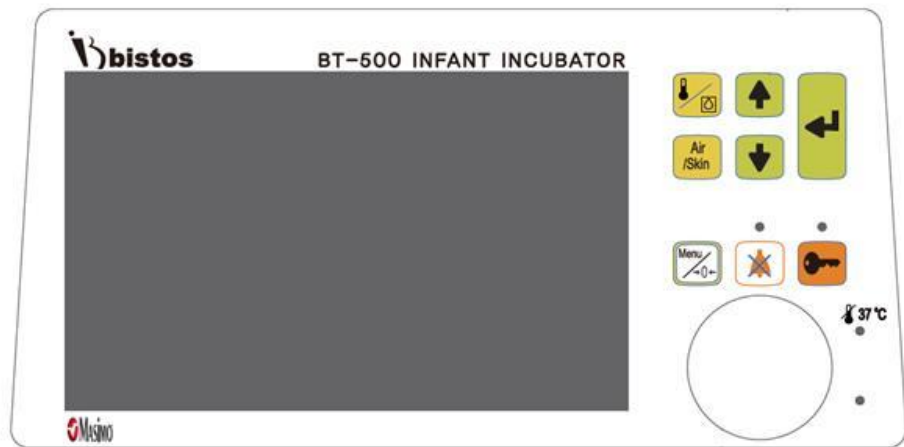

4.2 LED

The following symbols are functions and descriptions of LEDs on the control panel.

Symbol	Name	Description
	[Mute]	When alarm is activated, you can use this key to sound off during certain time. In this case, LED is on.
	[Keylock]	Lock the Key, used to unlock it. When key is locking, LED is on.
	[Override]	In override mode, LED is on.
	[AC power]	In case of AC power cord is disconnected by accident, LED is blinking.

Table 4-1. Function of LED

If the key beep is on, whenever you push any keys the beep sounds.

To use control panel, you must unlock the key lock function first. This is the protective method of misuse or unintended operation. To unlock the key locking function, you should use [Keylock] key. When you push [Keylock] key, LED is off. Then you can go into mode setting and setting of control parameters.

4.3 Key and knob operation

4.3.1 Key









Symbol	Name	Description
	[Parameter]	Use this key to select the parameter for set-up. Use this key to select the temperature, humidity (option : select the oxygen concentration)
	[Mode]	Use this key to select control mode.
	[Up]	Use this key to raise the parameter's value.
	[Down]	Use this key to lower the parameter's value.
	[Enter]	Use this key to enter the parameter's value to control mode.
	[Menu]	Use this key to enable the use of Knob to select menu options.
	[Mute]	Use this key to silent during a certain period of time in case of the alarm happened.
	[Keylock]	Use this key to Lock or unlock.

Table 4-2. Use of Key

4.3.2 Knob

Not only Knob is used for changing the setting value, but also it can be used for shifting and changing the Menu options. For changing the setting value, when the setting is complete, setting value is

reflected to control by pushing. For using the purpose of Menu option, you should  [Menu] when key locking is released.

Following table shows how to handle knob in each case.

Display window	Action	Description
Control setting value	Push	Reflect setting value.
	Rotate CW	+0.1 °C or +1 %
	Rotate CCW	-0.1 °C or -1 %
Menu	Push	Select options / Finish selecting options
	Rotate(CW/CCW)	Shift options and change setting value

Table 4-3. Use of Knob

4.4 Displays

BT-500 provides the one display screen and the one dynamic Menu window together. Figure 4-6 is the basic layout of BT-500.

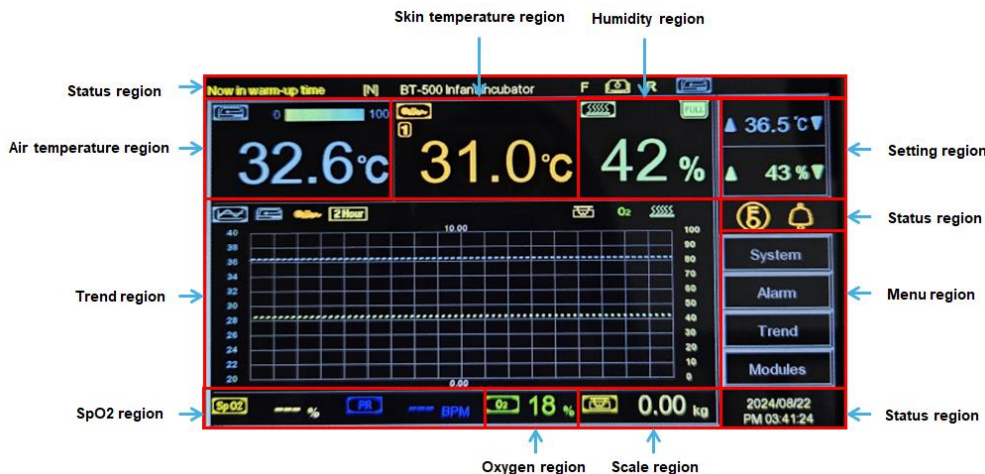

Figure 4-6. Main operation display

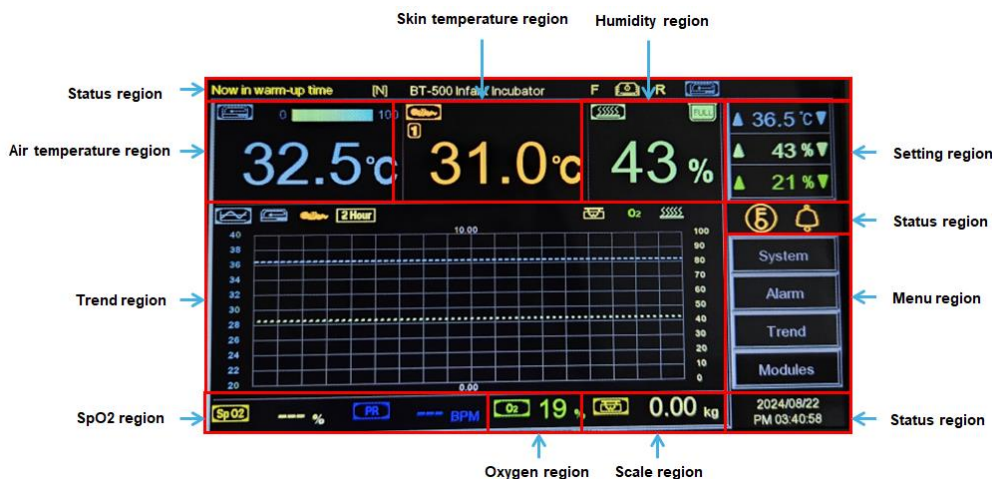

Figure 4-7. Basic screen of Main display (O2 control available)

① Air temperature region

This region displays the measured air temperature in the hood. Celsius(°C) or Fahrenheit(°F) can be displayed according to set. In case of module failure, connection failure and sensor failure is indicated by "--.-".

Note: In this region, current heater power is displayed by gauge .

② Skin temperature region

This region displays the patient’s skin temperature in the hood. Celsius(°C) or Fahrenheit(°F) can be displayed according to set. The case of module failure, connection failure and sensor failure is indicated by "--.-".

③ Humidity region

This region displays the measured relative humidity in the hood. Correct unit is %RH and % is displayed only.

Note: In this region, current water level is displayed by gauge. &

④ Setting region

In this region, according to control mode, especially air mode, user is able to set the temperature in the hood. In case of skin mode, user is able to set the patient's skin temperature in the hood. At this time, equipment does not control the temperature setting value that is lower than outer temperature. Also user can set the relative humidity in the hood.

Temperature Setting Value



Humidity Setting Value



⑤ SpO2 region

This region displays the lists of items regarding the SpO₂. SpO₂ value and PR(pulse rate) extracted from SpO₂ waveform are displayed with unit(% , bpm). When the signal is not measured, it is indicated as “---”.

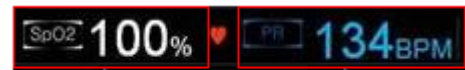

SpO₂ setting value

Pulse rate value

⑥ O2 region

This region displays the O₂ concentration by the % unit in the hood. When the O₂ sensor has malfunction or disconnection, it is indicated as “---”. When the O₂ sensor reaches the saturating concentration, it is indicated as “***”.

⑦ Scale region







This region displays weight of infant. When the scale module has malfunction or disconnection, it is indicated as “ Not installed”









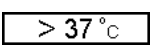

⑧ Status region

This region displays the Date/Time, patient ID, control mode icon, override mode icon, Keylock icon, and Sound icon. In control mode, there are air mode and skin mode and configuration color is changed by modes status. In override mode, air mode, if setting temperature is above 37.1 °C, skin mode, if setting temperature is above 37.6 °C, the setting can be executed with [keylock] key. In case of sound icon,

Press the [Mute]  button to pause the alarm sound.

Following listed indicates are used to identify the status the device.

Icon	Name	Description
	Air mode icon	Control mode status : Air mode
	Skin mode icon	Control mode status : Skin mode
	Humidity mode icon	Control mode status: Humidity mode
	Trend icon	Trend indication
	O ₂ icon	O ₂ indication
	SpO ₂ icon	SpO ₂ indication

Icon	Name	Description
	PR icon	Pulse rate indication
	Weight icon	Weighing scale indication
	Air/Skin temperature Override mode icon	Air/Skin temperature Override mode On.
	Key lock icon	Key is locking.
	Key unlock icon	Key input is enable..
	Alarm on icon	Alarm Sound on.
	Alarm off icon	Alarm Sound off.
	Door opened icon	Front and rear doors are open.
	Door closed icon	Front and rear doors are close open
	Door opened icon	Front door is open.
	Door opened icon	Rear door is open.

4.5 Temperature Measurement and Control

- Measurement: Measurement of air temperature and skin temperature are starting at the same time of BT-500 power on. In case of skin temperature, especially, metal part of skin temperature sensor probe must be attached to the infant's abdomen.
- Setting and Control
 - ① Air mode: The measured value is displayed on air temperature region in upper left of screen and the setting value is displayed on setting region in upper right of screen with blue.

1) To unlock the key, push the [keylock] key. (red underline on setting value)

2) Push the [Up] key  or rotate the knob CW to raise the setting temperature from 23.0°C to 37.0°C in 0.1°C increments. In temperature override mode, push the [Up] key or rotate CW the knob to raise the setting temperature from 37.1°C to 39.0°C.

Push the [Down] key  or rotate CCW the knob to lower the setting temperature from 39.0°C to 23.0°C in 0.1°C increments.



3) To confirm the setting value and lock the key, push the [keylock] key.

4) According to this value, the temperature of inside of the hood is controlled automatically.







Note: When key locking is released, LED is off and key lock icon is removed. Also, if no keys are pushed or knob is rotated within 10s of selecting display, it is automatically locked.

- ② Skin mode: The measured value is displayed on skin temperature region in upper middle of screen and the setting value is displayed on setting region in upper right of screen with yellow.

- 1) To unlock the key, push the [keylock] key. (red underline on setting value) By pushing [Mode] key , change control mode status.
 - 2) Push the [Up] key  or rotate the knob CW to raise the setting temperature from 35.0° to 37.5° in 0.1° increments. In temperature override mode, push the [Up] key or rotate CW the knob to raise the setting temperature from 37.6° to 39.0°.
- Push the [Down] key  or rotate CCW the knob to lower the setting temperature from 39.0° to 35.0° in 0.1° increments.
- 3) To confirm the setting value and lock the key, push the [keylock] key.
 - 4) To maintain the infant's body temperature, the temperature of inside of the hood is controlled automatically.
 - 5) When using two skin temperature sensors, it is displayed as shown. In order to use skin mode as the control mode, skin temperature 2 should be removed.



4.6 Humidity Measurement and Control

- Measurement: Humidity measurement starts at the same time when BT-500 is powered on.
- Setting and Control: The measured value is displayed on humidity region in upper middle of screen and the setting value is displayed on setting region in upper right of screen with sky-blue.
 - 1) To unlock the key, push the [keylock] key. (red underline on setting value) By pushing [Parameter] key , change the parameter.
 - 2) Push the [Up]  or [Down]  key or rotate the knob to raise or lower the setting humidity from 40% to 95% in 1%p increments.
 - 3) Push the [Enter]  button for reflecting set-up and push the [keylock]  key to lock.
 - 4) According to this value, the relative humidity of inside of the hood is controlled automatically.

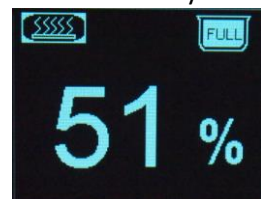

WARNING





- Premature neonates below 30 weeks may need humidity over 80% for long periods of time. In this high humidity environment, water vapor condensation could build up inside hood surface and prolonged condensation can lead to rain-out or watery surface underneath mattress. It is highly recommended that user should prevent water vapor

condensation by controlling temperature and humidity and clean out water vapor on the wall because of possible bacterial colonization.

4.7 O2 Measurement and Control

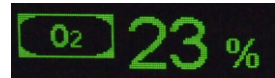
- Measurement: O2 concentration in the hood begins automatically starting operation at the same time. The measured value is displayed on O2 region in the lower of screen with green.
- Setting and Control: The measured value is displayed on O2 region in the lower of screen; setting value is displayed on setting region in upper right of screen with green.



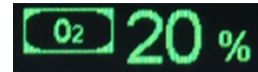

- 1) To unlock the key, push the [keylock] button. (red underline on setting value) By pushing [Parameter] key , change the parameter.





- 2) To unlock the key, push the [Keylock] key . (red underline on setting value)

- 3) To change the setting mode, push the [Parameter] key . Setting mode is Temperature, Humidity, Oxygen sequentially.



- 4) To set the key, push the [Up] , [Down] key  or control knob key to set the O2 concentration unit 1%

- 5) Press the [Enter] key  to reflect the setting and then press the [Keylock] key  to lock.

- 6) Adjust the O2 concentration in accordance with the setting value automatically.

WARNING



- Oxygen flow rate cannot guarantee the accuracy of oxygen concentration in the incubator.
- Oxygen concentration should be continuously measured by calibrated oxygen analyzer.
- Administration of oxygen may increase the noise level for the infant within the infant incubator.
- An oxygen analyzer shall be used separately when oxygen is delivered to the infant.
- Use of anesthetic agents can interfere with oxygen analyzer accuracy.
- As oxygen use increases the danger of fire, do not place auxiliary equipment that produces sparks in an incubator. Personal injury or equipment damage could occur.
- Disconnect the incubator from the hospital oxygen source when oxygen is not in use. Failure to do so could result in personal injury or equipment damage.

4.8 Weighing Scale Measurement

- Measurement: Weighing measurement starts at the same time when BT-500 is powered on. Measured data continuously displayed on lower part of screen in kg or pound unit according to set record.

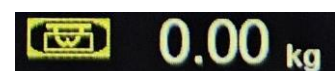

4.9 SpO2 and PR(pulse rate) Measurement

- Measurement: To measure SpO2, apply the probe to the patient’s toe or earlobe. The exact applied part is decided according to the medical opinion. The measured value is displayed on SpO2 region in lower of screen in white(SpO2) and blue(PR).



4.10 Menu functions

Functions of system, alarm, trend, and modules are able to be set and changed by using Menu options. After pushing the [keylock] key to unlock, press the [menu] key to go to the menu function.

To change and move to other category, use Control Knob. CW or CCW rotation of the Knob is used to shift between menu options and pushing is used to reflect the setting value. When the cursor is located on arrow, you can move to other menu category tabs.

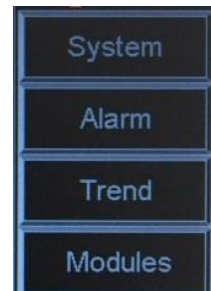

① System

You can change Temperature unit, Weight unit, Language, Time and Warm-up mode. There are 3 different kind of warm-up mode Silent, Normal, and Fast Mode.

- Silent: Warm-up time will take 1 hour around with noise level less than 45dB.
- Normal: Warm-up time will take 45Min around with noise level less than 55dB.
- Fast: Warm-up time will take 25Min. around with noise level more than 66dB.

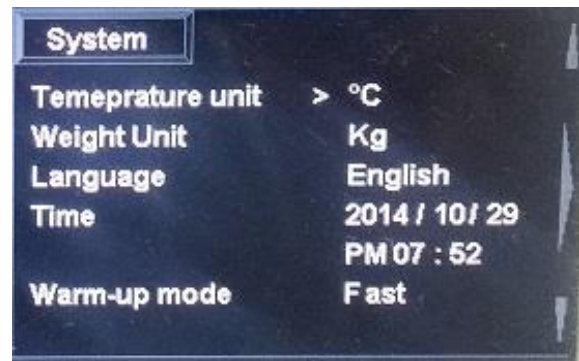

② Alarm

The silence period of alarm can be set to 2, 5, 10, 20 30, and 60 minutes. For the silence period, alarm sound is silent and silent time is displayed on main display.

SpO2 Alarm delay refers to the delay time after an alarm condition occurs, an alarm sounds until the occurrence. You can set the delay time 0,5,10 and 15 seconds.

And you can set PR Beep volume level. There are 5 different volume levels. All setting values for alarm condition do not be changed by any interrupt such as power on and off.

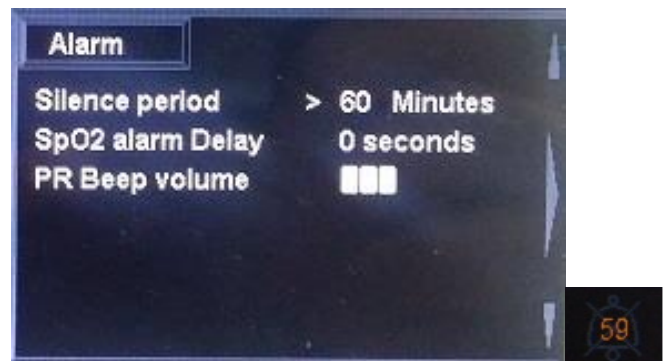

③ Trend

Trend period is set as 9, 18, 36, and 72 hours and it is displayed on main display. Also each trend display data are possible to enable or disable: air temperature, skin temperature, humidity and oxygen. These trend display datum are displayed on main operation display with setting period.

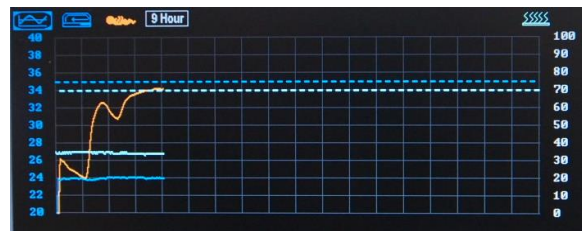
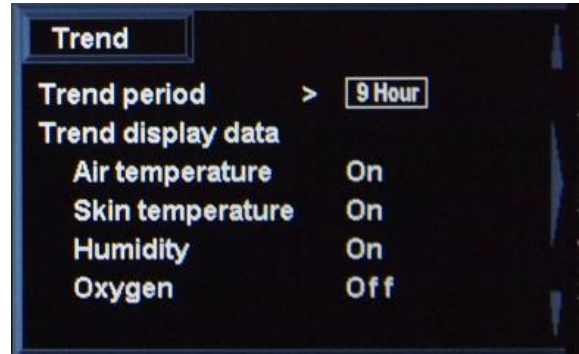

Trend display

④ Modules

The calibration of O2(21%, 100%, weight is available. Select the O2 setting mode or measured mode of main display. And select the Cam mode, Graph mode, Masimo mode of external monitor in the monitor mode function. Read the chapter 4.11 to understand explanation of each monitor mode. In addition, set the Cam. Hor. Mirror to reverse the display from side to side.

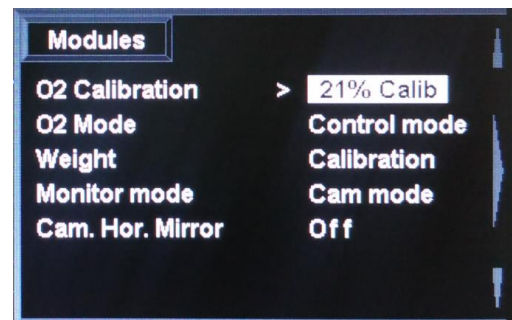

⑤ SpO₂

Below table is the description of SpO₂ setting menu. Please refer to below table to set SpO₂ settings. Changed setting will be apply on SpO₂ and display on external monitor, please refer to 4.11 for external monitor explanations.

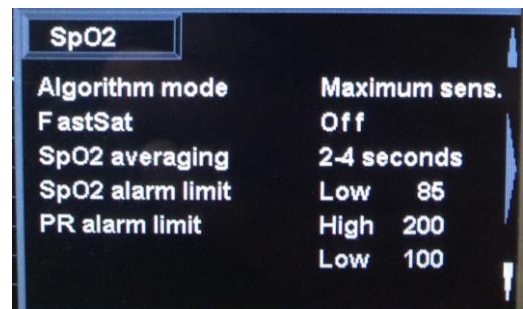

Items		Description
Algorithm mode	Normal sensitivity	This mode is provides the best combination of sensitivity and probe-off detection performance. This mode is recommended for the majority of patients.
	Maximum sensitivity	This mode should be used for the sickest patients, where obtaining a reading is most difficult. Maximum Sensitivity is designed to interpret and display data for even the weakest of signals. This mode is recommended during procedures and when clinician and patient contact is continuous.
	APOD	This mode is the least sensitive in picking up a reading on patients

Items		Description
		with low perfusion but has the best detection for prove-off conditions. This mode is useful for patients that are at particular risk of the sensor becoming detached. (Pediatric, combative, etc.)
FastSat	ON	This mode is always on for 2-4 and 4-6 averaging modes.
	OFF	-
SpO ₂ averaging	2 seconds	SpO ₂ averaging time
	4 seconds	
	8 seconds	
	10 seconds	
	12 seconds	
	14 seconds	
	16 seconds	
SpO ₂ alarm limit	Low	The range of 30 to 90 can be selectable.
PR Alarm limit	High	The range of 40 to 300 can be selectable.
	Low	The range of 30 to 290 can be selectable.



⑥ Help

BT-500 provide the simple information about the equipment. The information is as follow:

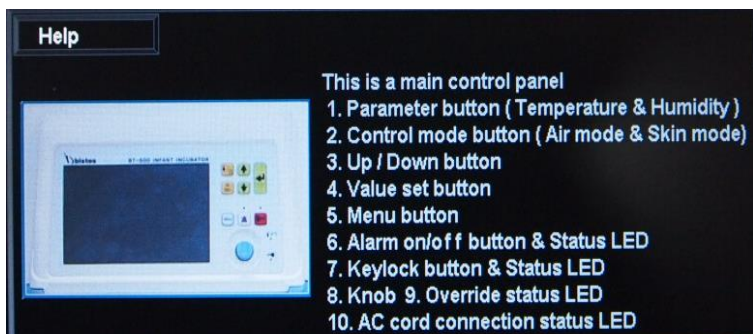
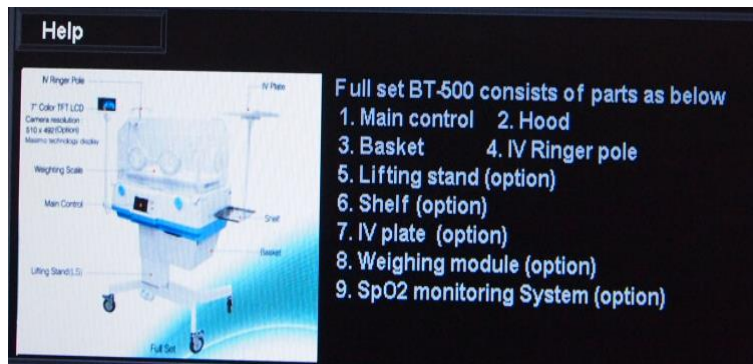
- parts of full set BT-500
- main control panel and main display
- how to use and change mode and parameters

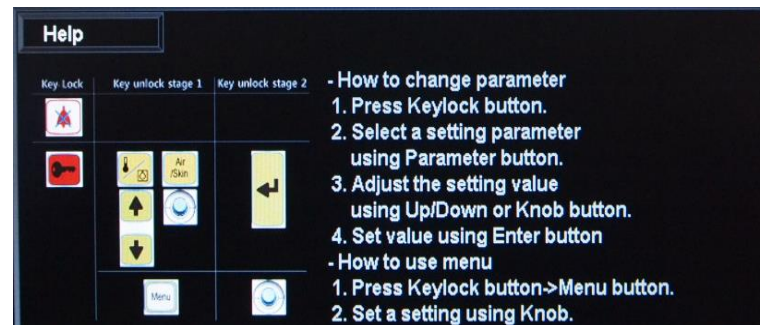
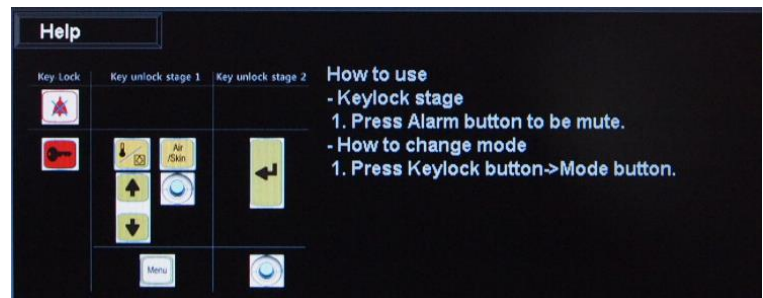
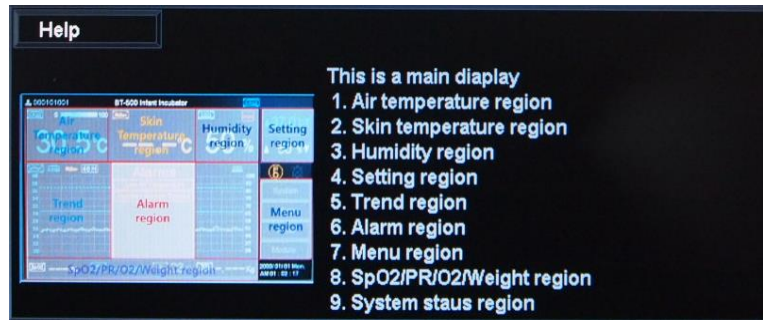



- ⑦ Scale : If weighing scale module is connected, a menu of weight calibration appears. Press the [keylock] key  to unlock and press the [Menu] key  more than 2 seconds then, the menu will be displayed.

4.11 Pulse Oximeter

WARNING



- Pulse oximeter of BT-500 must be operated by qualified personnel only.

Pulse oximetry is a continuous and non-invasive method of measuring the level of arterial oxygen saturation in blood. The measurement is taken by placing a sensor on a patient, usually on the fingertip/toe or foot for neonates. The sensor is connected to the pulse oximetry instrument with a patient cable. The sensor collects signal data from the patient and sends it to the instrument. The instrument displays the calculated data in two ways: 1) as a percent value for arterial oxygen saturation (SpO₂), and, 2) as a pulse rate (PR).

- **Operating Principles**

: The BT-500 MS board pulse oximeter is based on three principles:

1. Oxyhemoglobin and deoxyhemoglobin differ in their absorption of red and infrared light (spectrophotometry).
2. The volume of arterial blood in tissue and the light absorbed by the blood changes during the pulse (plethysmography).
3. Arterio-venous shunting is highly variables and that fluctuating absorbance by venous blood is a major component of noise during the pulse.

The pulse oximeter of BT-500 as well as traditional pulse oximetry determines SpO₂ by passing red and infrared light into a capillary bed and measuring changes in light absorption during the pulsatile cycle. Red and infrared light-emitting diodes (LEDs) in oximetry sensors serve as the light sources, a photodiode serves as the photodetector.

Traditional pulse oximetry assumes that all pulsations in the light absorbance signal are caused by oscillations in the arterial blood volume. This assumes that the blood flow in the region of the sensor passes entirely through the capillary bed rather than through any arterio-venous shunts. The traditional pulse oximeter calculates the ratio of pulsatile absorbance (AC) to the mean absorbance(DC) at each of two wavelengths, 660 nm and 905 nm:

$$S(660) = AC(660) / DC(660)$$

$$S(905) = AC(905) / DC(905)$$

The oximeter then calculates the ratio of these two arterial pulse-added absorbance signals:

$$R = S(660) / S(905)$$

This value of R is used to find the saturation SpO₂ in a look-up table built into the oximeter's software. The values in the look-up table are based upon human blood studies against a laboratory co-oximeter on healthy adult volunteers in induced hypoxia studies.

The Masimo SET MS board pulse oximeter assumes that arterio-venous shunting is highly variable and that fluctuating absorbance by venous blood is the major components of noise during the pulse. MS board decomposes S(660) and S(905) into an arterial signal plus a noise component and calculates the ratio of the arterial signals without the noise:

$$S(660) = S1 + N1$$

$$S(905) = S2 + N2$$

$$R = S1 / S2$$

Again, R is the ratio of two arterial pulse-added absorbance signals and its value is used to find the saturation SpO₂ in an empirically derived equation into the oximeter's software. The values in the empirically derived equation are based upon human blood studies against a laboratory co-oximeter on healthy adult volunteers in induced hypoxia studies.

The above equations are combined and a noise reference (N') is determined:

$$N' = S(660) - S(905) \times R$$

If there is no noise N' = 0: then S(660) = S(905) x R which is the same relationship for the traditional pulse oximeter.

The equation for the noise reference is based on the value of R, the value being sought to determine the SpO₂. The MS board software sweeps through possible values of R that corresponds to SpO₂

values between 1% and 100% and generates an N' value for each of these R -values. The S(660) and S(905) signals are processed with each possible N' noise reference through an adaptive correlation canceler (ACC) which yields an output power for each possible value of R (i.e., each possible SpO_2 from 1% to 100%). The result is a Discrete Saturation Transform (DST™) plot of relative output power versus possible SpO_2 value as shown in the following figure where R corresponds to $SpO_2 = 97\%$:

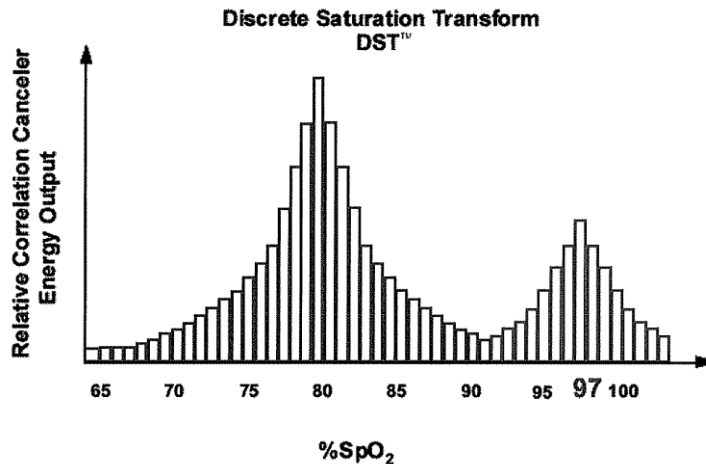

The DST plot has two peaks: the peak corresponding to the higher saturation is selected as the SpO_2 value. This entire sequence is repeated once every two seconds on the most recent four seconds of raw data. The MS board SpO_2 therefore corresponds to a running average of arterial hemoglobin saturation that is updated every two seconds.

- Grounding

Connect the oximeter only to a three-wire, grounded, hospital-grade receptacle. The three-conductor plug must be inserted into a properly wired three-wire receptacle; if a three-wire receptacle is not available, a qualified electrician must install one in accordance with the governing electrical code.

-
- WARNING**
- Do not remove the grounding conductor from the power plug on any circumstances.
 - Do not use extension cords or adapters of any type. The power cord and plug must be intact and undamaged.
-

If there is any doubt about the integrity of the protective earth conductor arrangement, operate the oximeter on internal battery power until the AC power supply protective conductor is fully functional.

- Patient Isolation

To ensure patient electrical isolation, connect only to other equipment with electronically isolated circuits.

Note: Do not connect to an electrical outlet controlled by a wall switch or dimmer.

- Cabling entanglement

As with all medical equipment, carefully route patient cabling to prevent the possibility of their entanglement or tightening patient.

WARNING • Do not place the monitor or external power supply in any position that might cause it to fall on the patient. Do not lift the monitor by the power supply cord or patient cable; use only the handle on the monitor



4.12 External Monitor

BT-500 uses external 7" Color TFT LCD monitor that displays measured values from the control and video of infant inside the hood. Cam mode, Graph mode and Massimo mode are shown as below.

(1) Cam Mode

Air temperature, skin temperature, humidity, oxygen concentration and Weighing scale are displayed on external monitor with real-time video of infant.

There is no information for the Masimo board. If there are some alarms, it would display message "Check alarm on Masimo mode".



(2) Graph Mode

Air temperature, skin temperature, humidity, oxygen concentration and Weighing scale, SpO₂ and PR are displayed on external monitor with real-time video of infant. Also, graphs of each parameter are displayed.

There is no information for the Masimo board. It just displays basic parameter (SpO₂, PR, Plethysmograph, and SIQ). If there are some alarms, it would display message "Check alarm on Masimo mode".



(3) Massimo Mode

Air temperature, skin temperature, humidity, oxygen concentration and Weighing scale are basically displayed. SpO₂ and PR are mainly displayed.

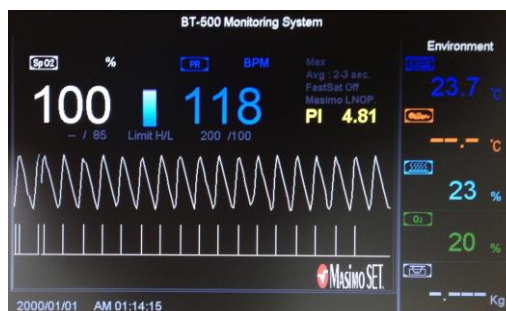

- Parameter Region

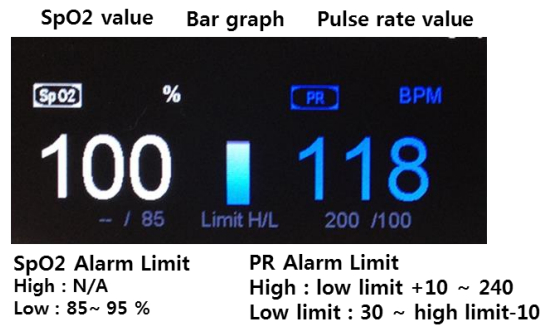

- Information Region

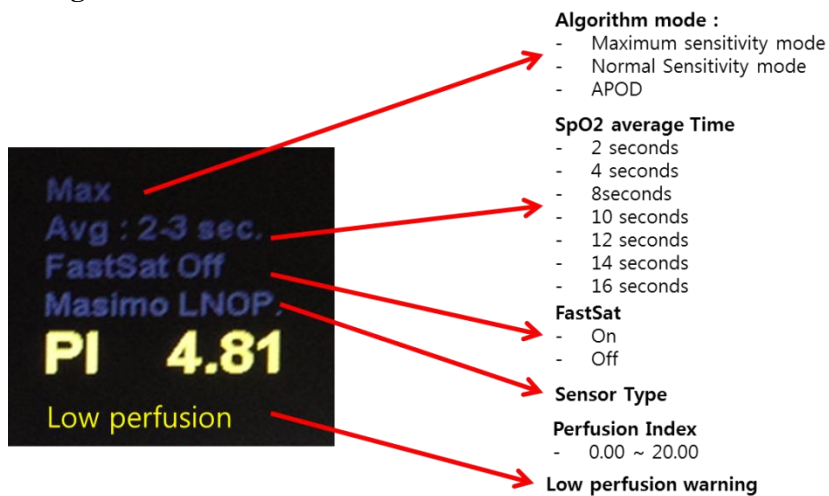

- PPG and SIQ Region



- Alarm messages on Alarm Region

According to each alarm condition, alarm messages are displayed in the center of the bottom on screen. For more detail information, see 8.2 Error message checking.

- Board failure & Diagnostic Failure code Region

Display when the event occurred. If no failure, it would be blanked. Each description about error codes is explained in Section 8.

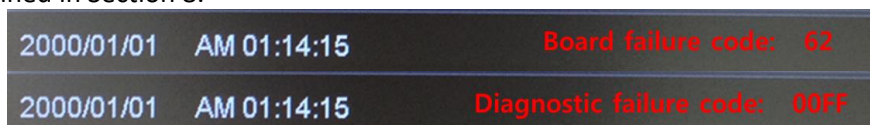

4.13 Shut down

To ensure safe terminating operation of BT-500, follow as below.

- 1) Turn off the Power switch to power down the incubator.
- 2) Turn off the main power source.



4.14 Calibration of O₂ module

WARNING • Recommended calibration is once per year.



Follow the direction to set and control O₂ concentration for improving accuracy in the hood of BT-500.

Calibration of O₂ concentration 21 %: Calibrate O₂ concentration to atmospheric oxygen concentration as the standard.

- 1) Move the position of the sensor module to O₂ calibration position. At this time, alarm can be occurred. But if sensor module relocates normal position after calibration, it operates normally.
- 2) To unlock the key, push the [keylock]  button. (red underline on setting value)
- 3) Press the [Menu]  button to enter the menu category. Select the O₂ Calibration category in [modules] category.
- 4) Handle the knob to select the 21 % Calibration category. Push the knob to complete the calibration.
- 5) If it is indicated as "Done" message, calibration completes the work. Otherwise, it is indicated as "Fail" message, check the O₂ sensor and atmospheric oxygen whether normal concentration.
- 6) Move the sensor module to normal position.

Calibration of O₂ concentration 100 %: Calibrate O₂ concentration to 100 %. Calibration of O₂ concentration 100 % should be performed after Calibration of O₂ concentration 21% is completed.

- 1) Move the position of the sensor module to O₂ calibration position. Sensor module and "O₂ calibration kit" place tight. At this time, alarm can be occurred. But if sensor module relocates normal position after calibration, it operates normally.
- 2) Connect "O₂ calibration kit" to be injected 100% O₂ concentration. Set oxygen flow to 0 PLM. Pressure of O₂ is between 40PSI(275kPa) and 50PSI(344kPa)
- 3) Turn "Sealing valve" clockwise to close contact with the sensor module and the "O₂ Calibration Kit".
- 4) Be careful not to obstruct the "O₂ calibration kit" of "O₂ outlet"
- 5) Inject oxygen into "O₂ calibration kit" At this time, the flow rate set between 5 LPM and 7 LPM (Litter Per Minute). Inject oxygen from 5 minute to 6minute to recognize O₂ sensor fully.
- 6) To unlock the key, push the [keylock] button. (red underline on setting value)
- 7) Press the [Menu]  button to enter the menu category. Select the O₂ Calibration category in [modules] category.
- 8) Handle the knob to select the 21 % Calibration menu. Push the knob to complete the calibration.
- 9) If it is indicated as "Done" message, calibration completes the work. Otherwise, it is indicated as "Fail" message, check the O₂ sensor and atmospheric oxygen whether normal concentration.

10) Move the sensor module to normal position.

5 Alarms

Alarm indicates the abnormal condition of the operating device.

According to each alarm condition, alarm messages are displayed in the pop-up window on the center of the screen. And the alarm light at the sensor module can be flashed and an audio alarm sounds.

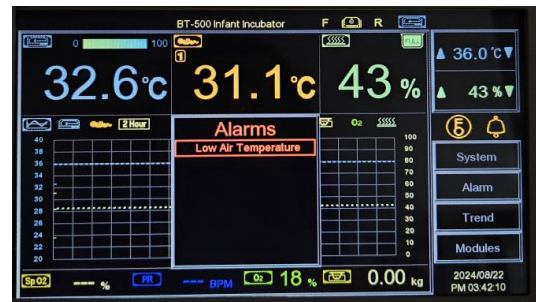

5.1 Alarm characteristics

1) Alarm priority

The audio alarm signal varies with the alarm priority.

① High alarm priority

The patient is in critical condition that should be immediately rescued. The device has a serious mechanical or electrical failure or malfunction, which means the patient is putting into the unintended environment or the device is unable to monitoring and control the environment.

- Alarm light: Red, flashes
- Audible alarm: Beep-beep-beep--beep-beep----beep-beep-beep--beep-beep
- Alarm information: Red

② Medium alarm priority

The device is in an abnormal condition including a mechanical or electrical failure or malfunction, which means the device does not a normal operation.

- Audible alarm: Beep-beep-beep
- Alarm information: Yellow

③ Low alarm priority

The device detects an abnormality that might lead to critical condition.

- Audible alarm: Beep
- Alarm information: Yellow

5.2 Alarm information

System alarm: The alarm informs a trouble of operating the devices. It is possible there will be a delay of 1 second to determine and check an accurate alarm condition		
Messages	Priority	description and countermeasures
N/A	High	Termination of AC power supply. Check whether power cord is disconnected with the device or outlet.
Fan power failure	High	There is a problem with power of impeller motor. It might need to replace the main board.
Motor failed	High	There is a problem with main motor. It might need to replace the main board.

Air circulation failure	High	There is a problem with not working or malfunction of impeller.
Heater system failed	High	There is a problem with main heater. It might need to replace the main heater module.
Humidity Heater failed	High	There is a problem with humidity heater. It might need to replace the humidity module.
Sensor mod disconnected	High	It cannot detect the sensor module. Check whether the module is disconnected.
Sensor module not in position	High	Sensor module is not placed in the proper position (in place that can measure the temp. and humidity condition inside of the hood).
Humidity sensor failure	High	There is a problem with air humidity measurement sensor in the hood
Skin probe fail	High	Skin temperature is disconnected in skin mode. Problem with the skin temp sensor.
Air sensor failure	High	There is a problem with air temperature measurement sensor in the hood
O2 Mod power failure	High	There is a problem with power of O2 control module.
O2 Mod Detached	High	The module is disconnected in O2 Control mode.
Stuck key	Medium	The key button has been pressed more than 1 minute.
Water Empty	Low	There is no water in the internal water tank.
Too much weight	Low	When weight in excess of 10kg is on the mattress. Which means another object except an infant is placed on the mattress

Temperature and humidity alarm: This alarm is activated when it exceed the control range.		
Messages	Priority	description and countermeasures
Low Air Temperature	High	If the temperature measured is lower than the set temperature over 2.5 °C
High Air Temperature	High	If the measured temperature is higher than the set temperature over 1.5 °C
Low Skin Temperature	High	If the temperature measured is lower than the set temperature over 1.0 °C
High Skin Temperature	High	If the measured temperature is higher than the set temperature over 1.0 °C
Remove Skin 2 probe	High	The measured value is abnormal. It requires removing the skin temperature sensor 2 during skin mode control.
High Skin 1 temperature	High	1) In case the measured temperature reaches more than 38 °C in normal mode. 2) In case the measured temperature reaches more than 39 °C in override mode.

High Skin 2 temperature	High	1) In case the measured temperature reaches more than 38 °C in normal mode. 2) In case the measured temperature reaches more than 39 °C override mode.
High Temperature cutout	High	1) In case the measured temperature reaches 37.5 °C ±0.5 °C in normal mode. 2) In case the measured temperature reaches more than 39.5 °C ±0.5 °C in override mode.
Low Humidity	High	Measured value is lower than setting value over 5%p.

Additional alarm: This alarm for optional configurations is activated when it exceed the control range.		
Messages	Priority	description and countermeasures
O2 Sensor Fault	High	If the measured values of the two O2 Sensor is a difference more than a certain concentration
Low Oxygen	High	Measured O2 concentration is lower than setting O2 concentration over 5 %
High Oxygen	High	Measured O2 concentration is higher than setting O2 concentration over 5 %
SpO2 Too Low	High	Measured SpO2 is lower than setting low limit.
PR Too High	High	Measured PR is higher than setting high limit.
PR Too Low	High	Measured PR is lower than setting low limit.

5.3 Alarm self-test

The self-testing is necessary for the alarm system to check whether the performance of the audible and visible alarms has degraded over time.

- System alarm
After removing the sensor module from the top of hood, check the followings. The message Sensor module not in position is displayed on LCD with the audible alarm. Also, the red LED flashes on the sensor moduel connector.
- Power fail alarm
If the power cable is disconnected with power on, the LCD screen turns off and the red LED flashes with a continuous audible alarm.

Note: A fully charged battery should supply the power failure alarm for approximately 30 minutes. If the alarm is tested for the full 10 minutes, BT-500 must be run at least 3 hours to recharge the battery before it is used to the patient. Total recharge time is 5 hours when the main power switch is on.

WARNING



- Do not place the monitor or external power supply in any position that might cause it to fall on the patient. Do not lift the monitor by the power supply cord

or patient cable; use only the handle on the monitor

- Do not conduct Alarm self-test whether the alarm function is working properly before being used again.
-

6 Cleaning & Maintenance

This chapter contains instructions for the care and cleaning of the BT-500 unit and its accessories.

The BT-500 requires proper care and preventive maintenance. This ensures consistent operation and maintains the high level of performance necessary.

6.1 General cleaning method and precautions

(1) Cleaning Methods

- You can maintain the cleanliness using various methods. Though, to avoid the damages or contamination, use the following recommended methods. .
- Clean up with warm water and detergent.
- Clean completely the incubator after each baby is discharged and before being used again.
- If you use the materials (unauthorized materials) that can cause damage to the device, it is impossible to get free repair service although the device is in warranty period.
- Do not use steam cleaning the all parts of incubator. The excessive moisture can cause damage.
- Please maintain cables with no dust and soil. And clean cables with wet fabric (water temperature is about 40°C / 104°F). Please clean cables using clinical alcohol once in a week.
- Do not immerse the device or sensor in liquid or a cleanser. Also all liquid must not be permitted to enter in the device or sensor.
- When cleaning the surface of the air circulation well, take care to prevent liquids from entering the motor. Then, dry with a clean cloth or paper towel.
- When you clean the sensor module, inner and outer wall of the hood, do not use alcohol that can cause crazing (small stress crack) of the clear acrylic.

WARNING



- Do not immerse the sensor in water, solvents, or cleaning solutions. Do not sterilize by irradiation, steam, or ethylene oxide.
 - Do not immerse the patient cable in water, solvents, or cleaning solutions (the patient cable connectors are not water proof). Do not sterilize by irradiation, steam, or ethylene oxide.
 - Incubator should be thoroughly cleaned and disinfected after each baby is discharged and before being used again. If patient is cared for in an incubator for more than 7 days without the device being cleaned or disinfected, it may cause an infection of patient.
-

(2) Maintenance Methods

- Once a month, rub the main body and accessories using soft fabric with alcohol. Do not use thinner, lacquer, ethylene or oxidant.
- After using the device, please store the device where the place has -20°C~+60°C of temperature and 0%~95% of humidity.
- Restrict the device be used by doctors and nurses only.

-
- WARNING**  • Functional testers cannot be used to evaluate the accuracy of pulse oximetry and pulse oximetry.
-

6.2 Hood

Keep the external surface clean and free of dust, dirt, and residual liquids. Clean with a damp cloth using mild soap and water or hospital approved, nonabrasive disinfectants.

-
- WARNING**  • Turn off the BT-500 and unplug the BT-500 from the AC power source and detach all accessories before cleaning. Do not immerse the unit in water or allow liquids to enter the case.
- Do not use alcohol for cleaning. Alcohol can cause crazing of the clear acrylic hood.
-

6.3 Shell, Sensor module, Scale module, Basket

Keep the external surface clean and free of dust, dirt, and residual liquids. Clean with a damp cloth using mild soap and water or hospital approved, nonabrasive disinfectants.

-
- WARNING**  • Turn off the BT-500 and unplug the BT-500 from the AC power source. Do not immerse the unit in water or allow liquids to enter the case.
- Do not allow liquids to enter when clean the console box. Failure to do so could result in personal injury or equipment damage.
 - Be careful not to have a burn when clean the radiator of shell. Check the temperature of the radiator before cleaning.
-

-
- CAUTION**  • Take extra care when cleaning the display surfaces, which are sensitive to rough handling. Rub the lens that covers them with a soft, dry cloth.
-

6.4 Water tank

Maintain inside of the water tank clean from the dust, the residue, the remaining liquid. Use the mild soap, water, non-abrasive sanitizer approved in the hospital and wipe with damp cloth. Also, the water tank can be disinfected by using autoclave.

-
- WARNING**  • Do not remove and clean the humidity module in operation.
- The humidifier reservoir (water tank) should be cleaned and the water changed every day.
 - Do not autoclave the components of device, except for water tank specifically identified in this chapter.
-

6.5. Skin temperature sensors and SpO2 sensors

Keep the external surface clean and free of dust, dirt, and residual liquids. Clean with a damp cloth using mild soap and water or hospital approved, nonabrasive disinfectants

-
- WARNING**  • All Masimo sensors and accessories listed to be available for device.
-

6.6 Drain of residual water

The residual water in the humidity module can cause bacteria multiplication or equipment damage when it is frozen. When the infant leave the hospital or the equipment not being used, remove the residual water in the humidity module as follows:

- 1) To cool down the humidity module, turn off the BT-500 and remove water tank and wait about 60 minutes.
- 2) Remove the basket from the bottom side as shown in the figure. Place the water tank more than 1L capacity below the drain valve.
- 3) Remove the drain valve from shell bottom by hand or using the screwdriver.
- 4) Waiting until no more water has fall down from the drain and turn on the BT-500.
- 5) Press down the [Parameter] key  more than 5 seconds and the system will ask the password. Enter [0,0,1,1] to start the heater operated to remove the moisture from humidity module. For drying out the humidity module, the heater will be operating about 4minutes and 40 seconds. Be careful the heated vapor can be expelled at the drain valve.
- 6) The BT-500 will be reset. Turn the power off and assemble the drain valve as reverse order.

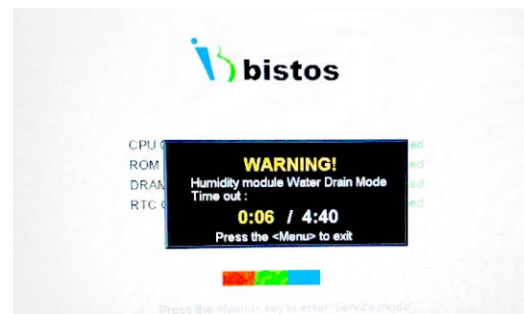
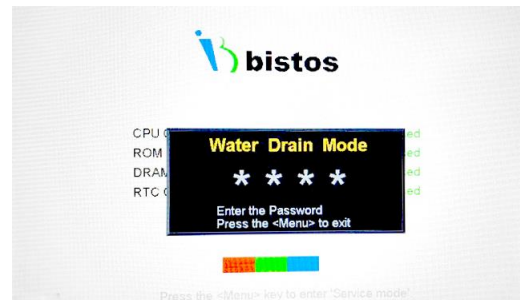

WARNING



- The humidity module can be sufficiently hot to cause burns.
- The hot water can be poured from drain valve.

6.7 Regular Inspection

Similar to most medical equipment, BT-500 has to be inspected periodically on an annual basis in general. Refer to the service manual which is supported by Bistos Co.,Ltd. about inspectional items. Regular inspection must be performed by the company’s technician. The user and operator must not disjoint or remodel the device.

WARNING



- The operation of each part should be checked every time before the device is used to patient.
- The operation of each function should be checked every three-month in general.
- If any defect should be detected in an inspection, indicate on the unit that it is out of order, stop using it immediately, and contact our distributor in local area.

6.8 Battery Replacement and Disposal

If a loss of battery operation run time is noticed, the battery could possibly require replacement. When disposing or replacing of internal Li-ion battery, adhere to all applicable laws regarding recycling. Avoid storing battery above 140°F. If clothing or skin comes in contact with material from inside the battery, immediately wash with plenty of clean water.

CAUTION  • The internal battery must be handled by the company’s technician only. Do not attempt to open the BT-500.

The internal battery is consumables. Therefore the operation time by the battery can be decreased. If the operation time is not long enough, please contact service center and change the battery. If this system is used with not sufficient operating time by the internal battery, it is possible to be shut down the system because of the lack of the internal battery’s capacity. This situation can cause not intended stop of measuring and monitoring function.

6.9 Disposal of the BT-500

When disposing of the BT-500, adhere to all applicable laws regarding recycling. If you are not able to dispose the BT-500 or you need a help for disposing the BT-500, please contact us. In the case of there are no appropriate ways to dispose, we will pick up the BT-500 for you.

DISPOSAL

	<p>In order to comply with EU Directive 2002/96/EC on Waste Electrical and Electronic Equipment (WEEE): This product may contain material which could be hazardous to human health and the environment. DO NOT DISPOSE of this product as unsorted municipal waste. This product needs to be RECYCLED in accordance with local regulations, contact your local authorities for more information. This product may be returnable to your distributor for recycling - contact the distributor for details.</p>
---	--

7 Specifications

Physical characteristics	
Standard	Dimension: 1,024(W)x690(D)x1,354(H)mm Weight: Approx. 99.3 Kg
Full loaded (including IV pole, IV plate, plate, external LCD monitor, shelf, weighing scale, CCD camera, lifting stand, O ₂ control module and check valve)	Dimension: 1,441(W)x797(D)x1,500(H)mm Weight: Approx. 117.5 Kg Safe working load: approx. 156.5 Kg
Body (Shell + Hood)	Dimension: 1,024(W)x604(D)x773(H)mm Weight: Approx. 52.7 Kg
Fixed stand	Dimension: 1,009.5(W)x815(D)x645(H)mm Weight: Approx. 36 Kg
Lifting stand	Dimension: 1,441(W)x797(D)x1,500(H)mm Weight: Approx. 40.5 Kg
IV plate	Dimension: 479(W)x402(D)x756.4(H)mm Weight: Approx. 5 Kg
Plate	Dimension: 402(W)x302(D) Weight: Approx. 11 Kg
IV pole	Dimension: 300(W)x310(D)x718 ~ 1,068(H)mm

	Weight: Approx. 2.5 Kg
External 7" color TFT LCD	Dimension: 364.7(W)x35(D)x839(H)mm Weight: Approx. 3 Kg Tilt angle: +30° / -50° Swivel angle: +180° / -140°
Shelf	Dimension: 219(W)x334(D)x36(H)mm Weight: Approx. 2.7 Kg Weight limit: approx. 3 Kg
Basket	Dimension: 464.2(W)x490.5(D)x241.3(H)mm Weight: Approx. 4.3 Kg Weight limit: approx. 10 Kg
Basket partition	Dimension: 391(W)x205(D)x53(H)mm Weight: Approx. 0.45 Kg
Weighing scale	Dimension: 810(W)x400(D)x46.6(H)mm Weight: Approx. 5.8 Kg Measurement range: 0 ~ 10 Kg, ±50g
CCD camera (NTSC or PAL)	Dimension: 69.1(W)x46(D)x38(H)mm Weight: Approx. 40 g Resolution: 510x492 pixel
Sensor module	Dimension: 157(W)x119.2(D)x64.5(H)mm Weight: Approx. 270 g
Sensor module & CCD camera assembly	Dimension: 194(W)x119.2(D)x81(H)mm Weight: Approx. 310 g
SpO ₂ probe	Wire length: 1,000 mm Weight: approx. 30 g
SpO ₂ probe extension	Wire length: 3,080 mm Weight: approx. 30 g
Mattress	Dimension: 727(W)x377(D)x27(H)mm Weight: Approx. 30 g Tilt angle: ±12°
O ₂ control module	Dimension: 300(W)x170(D)x180(H)mm Weight: Approx. 760 g
Check valve	Dimension: 330(W)x365(D)x65(H)mm Weight: Approx. 460 g

The following materials are used

Mattress	Polyurethane
----------	--------------

Functional Characteristics

Air temperature: control and measurement of air temperature in the hood

Control range	Normal mode: 23.0 °C ~ 37.0 °C Override mode: 37.1 °C ~ 39.0 °C
Measurement range	20.0 °C ~ 45.0 °C
Accuracy	± 0.5 °C

Skin temperature: control and measurement of skin temperature of the infant

Control range	Normal mode: 35.0 °C ~ 37.5 °C Override mode: 37.6 °C ~ 39.0 °C
Measurement range	25.0 °C ~ 45.0 °C
Accuracy	± 0.5 °C
Accuracy of skin temperature sensor	± 0.3 °C

Humidity: control and measurement of relative humidity in the hood

Control system	Steam humidifier
Control range	30 %RH ~ 95 %RH

Measurement range	15 %RH ~ 99 %RH		
Accuracy	± 5 %p		
Autoclavable water box			
O₂: measurement of O₂ in the hood			
Measurement range	18 % ~ 100 %		
Accuracy	± 5 %p		
O₂: servo control of O₂ in the hood			
Control range	21 % ~ 65 %		
Accuracy	± 5 %p		
Max inlet pressure	120 psi		
Hose diameter	8mm, 9.5mm, 11mm, 13mm (Use only oxygen hose)		
Weighing scale: measurement of weight of the infant			
Measurement range	0.00 kg ~10.00 kg		
Accuracy	± 50 g		
Pulse rate(PR): measurement of pulse rate of the infant			
Measurement range	30 bpm ~ 240 bpm		
Error tolerance (Without movement noise)	± 3 bpm		
Resolution	1 bpm		
SpO₂: measurement of SpO₂ of the infant			
Measurement range	1 % ~ 100 %		
Accuracy (Without movement noise)	70 % ~ 100 %, ± 3 % 0 % ~ 69 %, unspecified		
Resolution	1 %		
NOTE: Below contents were cited by IFU of Masimo sensor			
Arms accuracy is a statistical calculation of the difference between device measurements and reference measurements. Approximately two-thirds of the device measurements fell within +/- Arms of the reference measurements in a controlled study.			
SpO ₂ accuracy was determined by testing on healthy adult volunteers with light to dark skin in the range of 70% - 100 % SpO ₂ against al laboratory co-oximeter. Accuracy specifications are statistically distributed, and only about two-thirds of the measurements fall within the 1 Std. Dev. specification.			
Power (AC)		Internal battery	
Input	AC 100/240, 50/60Hz	Li-ion rechargeable battery (3.7V, 2600mAh)	
Consumption	1200VA	5 hours to full charge when main power switch is on. Alarm sounds for 30 minutes while no power	
Operation environment		Storage environment	
Temperature	20 ~ 30°C (68 ~ 86°F)	Temperature	-20 ~ 60°C (4 ~ 140°F)
Humidity	0 ~ 95% non-condensing	Humidity	0 ~ 95% non-condensing
Air pressure	70~106 kPa	Air pressure	70~106 kPa
Altitude	0 - 2,000m(0 – 6,561.68 ft)	Altitude	0 - 2,000m(0 – 6,561.68 ft)
Other environment			
Maximum carbon dioxide(CO ₂) concentration	<0.5% at a point 15cm above from the center of the mattress		
Air velocity over the mattress	<0.3 m/s		
Warm-up time	Normal mode: 45 minutes, <55 dBA Silent mode: 60 minutes, <45 dBA Fast mode: 30 minutes, >66 dBA		
Sound pressure level in hood	The compartment sound level when the background sound level is 45 dBA or less: ≤ 60 dBA		
Standard			
Complies with IEC60601-1, IEC60601-1-2, IEC60601-2-19 and ISO 80601-2-61			
Class I equipment & Internal powered equipment			
Continuous operation			
Type BF applied part			

Skin temperature probe: IPX1	
SpO2 probe: IPX2	
Foot switch: IPX6	
Alarm signal sound pressure	
Priority	High (All)
Measured sound pressure level	73 dBA
A-weighted background level	48 dBA

8 Troubleshooting

8.1 General Checking

When the following problems are happened, before contact the head office, please check following measures.

1. When you can't power on the device.
 - Please check that an adaptor of the device is connected to the AC connector properly.
 - Please check the LED in the front panel is green or yellow.
2. When values are not displayed
 - Please check that sensor and extension cables are properly connected to sensor connector.
 - Please check that sensor works properly after connect cables.
3. When values are not in proper range
 - Please check if the hood is closed well.
 - Please check the probe is attached properly.
 - When setting the scale to zero or measuring weight, please check if any object is placed on the measuring plate.

If the unit has trouble, check the possible cause in sequence from above.

8.2 Error Message Checking

If the BT-500 has some problem for operation, it display alarm messages as below.

- Alarm messages on Main Display

Alarm Messages	Cause	Solution
Motor Failed	Motor driver malfunction	Replace the main board (BD-500-MAIN)
Overburned Heater	Main heater overheated caused by the broken impeller of Main fan motor or thermostat malfunction	Stop the operation of BT-500 and contact to the distributor or BISTOS.
Humidity Heater failed	Water heater of humidity module malfunction	Check the fuse F1 of BD-500-MAIN. If the fuse F1 is broken, replace it. If not, replace the humidity module.
Heater system failed	Main heater of shell malfunction	Check the fuse F1 of BD-500-MAIN. If the fuse F1 is broken, replace it. If not, replace the humidity module.
Stuck key	Key or knob is stuck.	Check key and knob if they are stuck. Replace U3 of BD-500-CPU CTRL.
Air sensors failure	Air temperature sensor malfunction	Replace CIR-500-sensor sub or CIR-500-sensor
Sensor mod	Disconnected the sensor module	Connect the sensor module to shell.

disconnected		
Sensor module not in position	Sensor module not in position on hood	Check the position of the sensor module.
Skin Probe Disconnect	In Skin mode, Skin sensor probe is disconnected from connector. .	Connect the skin sensor probe, or change the control mode to air mode.
Fan power failure	Fan power system malfunction	Replace the main board (BD-500-MAIN)

- **Alarm messages on Alarm Region of External Monitor**

Alarm Messages	Solution
Bad Sensor ID offset	Check the sensor status. If you are not able to comprehend the causes, connect the service personnel.
Open LEDs	
Short detector	
Interference detected	
Shorted LEDs	
No adhesive sensor	
No cable	
No sensor connected	
Sensor off patient	
Too much ambient light	
Unrecognized sensor	
Low SpO2	Check the patient status.
High pulse rate	
Low pulse rate	

- **Error codes of External Monitor**

If the external monitor displays alarm error codes such as board failure codes and diagnostic failure codes as below. For this, connect the service personnel immediately.

Board Failure Codes	Meaning
32	DSP: Checksum failure
33	DSP: Program memory test failure
34	DSP: Data Memory test failure
35	DSP: Detector ADC Interrupt Test Failure
36	DSP: MCU Interrupt failure
37	DSP : Diag queue Overrun
38	DSP : Hardware Status Failure
39	DSP : Raw Queue Overrun
40	DSP: MCU Watch Dog Failure

Diagnostic failure Code	Meaning
0001	LED Ground
0002	Reference Voltage
0004	Digital Voltage
0008	DSP Voltage
0010	Positive LED Voltage

0020	Red current level
0040	IR Current level
0080	Digital ground
0100	Positive Preamp voltage
0200	Preamp
0400	Positive Detector voltage
0800	Negative Detector voltage
1000	LED current
2000	Analog ground
4000	LED drive voltage
8000	Sensor ID

9 Declaration on EMC

BT-500 needs special precautions regarding EMC (Electromagnetic compatibility) and needs to be used according to the EMC information provided in this user manual. Wireless communications equipment such as wireless home network devices, mobile phones, cordless telephones and their base stations, walkie-talkies can affect the BT-500 and should be kept at least 1 m away from the equipment.

9.1 Electromagnetic emissions

The BT-500 is intended for use in the electromagnetic environment specified below. The customer or the user of the BT-500 should assure that it is used in such an environment.		
Emissions test	Compliance	Electromagnetic environment - guidance
RF emissions CISPR 11	Group 1	The essential performance of the BT-500, Infant incubator, is to provide an enclosed controlled environment to maintain appropriate temperature and humidity levels for infant. So there is no intentional or controlled RF emission for its intended performance. Therefore, its RF emissions are very low and are not likely cause any interference with nearby electronic equipment.
RF emissions CISPR 11	Class A	The BT-500 is suitable for use in all establishments other than domestic, and may be used in domestic establishments and those directly connected to the public low-voltage power supply network that supplies buildings used for domestic purpose.
Harmonic emissions IEC 61000-3-2	Class A	Warning: This BT-500 is intended for use by healthcare professionals only. This equipment/system may cause radio interference or may disrupt the operation of nearby equipment. It may be necessary to take mitigation measures, such as re-orienting or relocating the BT-500 or shielding the location.
Voltage fluctuations / flicker emissions IEC 61000-3-3	Complies	

9.2 Recommended separation distances between portable and mobile RF communications equipment and the BT-500

The BT-500 is intended for use in an electromagnetic environment in which radiated RF disturbances are controlled. The customer or the user of the BT-500 can help prevent electromagnetic interference by maintaining a minimum distance between portable and mobile RF communications equipment (transmitters) and the BT-500 as recommended below, according to the maximum output power of the communications equipment.

Rated maximum output power of transmitter [W]	Separation distance according to frequency of transmitter [m]		
	150 kHz to 80 MHz $d = 1,2\sqrt{P}$	80 MHz to 800 MHz $d = 1,2\sqrt{P}$	800 MHz to 2.5 GHz $d = 2,3\sqrt{P}$
0.01	0.12	0.12	0.23
0.1	0.38	0.38	0.73
1	1.2	1.2	2.3
10	3.8	3.8	7.3
100	12	12	23

For transmitters rated at a maximum output power not listed above, the recommended separation distance d in meters (m) can be estimated using the equation applicable to the frequency of the transmitter, where P is the maximum output power rating of the transmitter in watts (W) according to the transmitter manufacturer.

NOTE 1) At 80 MHz and 800 MHz, the separation distance for the higher frequency range applies.
 NOTE 2) These guidelines may not apply in all situations. Electromagnetic propagation is affected by absorption and reflection from structures, objects and people.

9.3 Electromagnetic immunity

The BT-500 is intended for use in the electromagnetic environment specified below. The customer or the user of the BT-500 should assure that it is used in such an environment.

Immunity test	IEC 60601 Test level	Compliance level	Electromagnetic environment - guidance
Electrostatic discharge (ESD) IEC 61000-4-2	±8 kV Contact ±2kV, ±4kV, ±8kV, ±15kV Air	±8 kV Contact ±2kV, ±4kV, ±8kV, ±15kV Air	Floors should be wood, concrete or ceramic tile. If floors are covered with synthetic material, the relative humidity should be at least 30 %.
Electrical fast transient/burst IEC 61000-4-4	230 V~ 50 Hz Power supply line, ±2 kV AC, 100 kHz PRR	230 V~ 50 Hz Power supply line, ± 2 kV AC, 100 kHz PRR	Mains power quality should be that of a typical commercial or hospital environment.

Surge IEC 61000-4-5	230 V~ 50 Hz Power supply line, ±0.5kV,±1kV L1 to L2	±1 kV line(s) to line(s) ±2 kV line(s) to earth	Mains power quality should be that of a typical commercial or hospital environment.
Voltage dips, short interruptions and voltage variations on power supply input lines IEC 61000-4-11	100V~ 50 Hz, 240 V~ 50 Hz Power supply line 0 % UT for 0.5 cycle 0% UT for 1 cycle 50 Hz : 70 % UT for 25 cycles 60 Hz : 70 % UT for 30 cycles 50 Hz : 0 % UT for 250 cycles 60 Hz : 0 % UT for 300 cycles	100V~ 50 Hz, 240 V~ 50 Hz Power supply line 0 % UT for 0.5cycle 0% UT for 1 cycle 50 Hz : 70 % UT for 25 cycles 60 Hz : 70 % UT for 30 cycles 50 Hz : 0 % UT for 250 cycles 60 Hz : 0 % UT for 300 cycles	Mains power quality should be that of a typical commercial or hospital environment. If the user of the BT-500 infant incubator requires continued operation during power mains interruptions, it is recommended that the BT-500 infant incubator be powered from an uninterruptible power supply.
Power frequency (50 Hz and 60 Hz) magnetic field IEC 61000-4-8	30A/m	30A/m	Power frequency magnetic fields should be at levels characteristic of a typical location in a typical commercial or hospital environment.
NOTE U_T is the a.c. mains voltage prior to application of the test level.			

Immunity test	IEC 60601 test level	Compliance level	Electromagnetic environment - guidance
Conducted RF IEC 61000-4-6	230 V~ 50 Hz Power supply line	230 V~ 50 Hz Power supply line	
	3 Vrms, 150kHz -80MHz	3 Vrms, 150kHz -80MHz	
	6 Vrms in ISM Bands between 0.15MHz and 80 MHz	6 Vrms in ISM Bands between 0.15MHz and 80 MHz	
Radiated RF IEC 61000-4-3	3 V/m, 10 V/m 80 MHz to 2.7 GHz 80%, 1 kHz AM	3 V/m, 10 V/m 80 MHz to 2.7 GHz 80%, 1 kHz AM	
	RF Wireless Comm. (Refer to test report clause 1.15)	RF Wireless Comm. (Refer to test report clause 1.15)	
<p>^a Field strengths from fixed transmitters, such as base stations for radio (cellular/cordless) telephones and land mobile radios, amateur radio, AM and FM radio broadcast and TV broadcast cannot be predicted theoretically with accuracy. To assess the electromagnetic environment due to fixed RF transmitters, an electromagnetic site survey should be considered. If the measured field strength in the location in which the BT- BT-500 is used exceeds the applicable RF compliance level above, the BT-350 should be observed to verify normal operation. If abnormal performance is observed, additional measures may be necessary, such as re-orienting or relocating the BT-500.</p> <p>^b Over the frequency range 150 kHz to 80MHz, field strengths should be less than 3 V/m.</p>			

Product Warranty

Product Name	Infant Incubator
Model Name	BT-500
Serial No.	
Warranty Period	2 Years
Date of Purchase	
Customer	Hospital: Address: Name: Telephone:
Sales Agency	
Manufacture	Bistos Co., Ltd.

- ※ Thank you for purchasing BT-500.
- ※ This product is manufactured and passed through strict quality control and inspection.
- ※ Compensation standard concerning repair, replacement, refund of the product complies with “**Framework Act on Consumers**” noticed by Fair Trade Commission of Republic of Korea.

Service Telephone and Fax. Numbers

Telephone: +82 31 750 0340

Fax: +82 31 750 0344



Bistos Co., Ltd.

7th FL., A Bldg., Woolim Lions Valley 5-cha, 302,
Galmachi-ro, Jungwon-gu, Seongnam-si,
Gyeonggi-do, Korea

www.bistos.co.kr

bistos@bistos.co.kr

EC REP Obelis s.a

Bd. Général Wahis 53
1030 Brussels, BELGIUM

Telephone: + (32) 2. 732.59.54

Fax.: + (32) 2.732.60.03

